

По вопросам продаж и поддержки обращайтесь:

Алматы (7273)495-231
Ангарск (3955)60-70-56
Архангельск (8182)63-90-72
Астрахань (8512)99-46-04
Барнаул (3852)73-04-60
Белгород (4722)40-23-64
Благовещенск (4162)22-76-07
Брянск (4832)59-03-52
Владивосток (423)249-28-31
Владикавказ (8672)28-90-48
Владимир (4922)49-43-18
Волгоград (844)278-03-48
Вологда (8172)26-41-59
Воронеж (473)204-51-73
Екатеринбург (343)384-55-89

Иваново (4932)77-34-06
Ижевск (3412)26-03-58
Иркутск (395)279-98-46
Казань (843)206-01-48
Калининград (4012)72-03-81
Калуга (4842)92-23-67
Кемерово (3842)65-04-62
Киров (8332)68-02-04
Коломна (4966)23-41-49
Кострома (4942)77-07-48
Краснодар (861)203-40-90
Красноярск (391)204-63-61
Курган (3522)50-90-47
Курск (4712)77-13-04
Липецк (4742)52-20-81

Магнитогорск (3519)55-03-13
Москва (495)268-04-70
Мурманск (8152)59-64-93
Набережные Челны (8552)20-53-41
Нижегород (831)429-08-12
Новокузнецк (3843)20-46-81
Новосибирск (383)227-86-73
Ноябрьск (3496)41-32-12
Омск (3812)21-46-40
Орел (4862)44-53-42
Оренбург (3532)37-68-04
Пенза (8412)22-31-16
Пермь (342)205-81-47
Петрозаводск (8142)55-98-37
Псков (8112)59-10-37

Ростов-на-Дону (863)308-18-15
Рязань (4912)46-61-64
Самара (846)206-03-16
Санкт-Петербург (812)309-46-40
Саранск (8342)22-96-24
Саратов (845)249-38-78
Севастополь (8692)22-31-93
Симферополь (3652)67-13-56
Смоленск (4812)29-41-54
Сочи (862)225-72-31
Ставрополь (8652)20-65-13
Сургут (3462)77-98-35
Сыктывкар (8212)25-95-17
Тамбов (4752)50-40-97
Тверь (4822)63-31-35

Тольятти (8482)63-91-07
Томск (3822)98-41-53
Тула (4872)33-79-87
Тюмень (3452)66-21-18
Улан-Удэ (3012)59-97-51
Ульяновск (8422)24-23-59
Уфа (347)229-48-12
Хабаровск (4212)92-98-04
Чебоксары (8352)28-53-07
Челябинск (351)202-03-61
Череповец (8202)49-02-64
Чита (3022)38-34-83
Якутск (4112)23-90-97
Ярославль (4852)69-52-93

Россия +7(495)268-04-70

Казахстан +7(7172)727-132

Киргизия +996(312)96-26-47

mvi@nt-rt.ru || <https://mgb.nt-rt.ru>

LAPAROSCOPY PELVISCOPY



CONTENT

LAPAROSCOPY – PELVISCOPY

■ Telescopes	Page 3-4
■ Hand Instruments & Handles	Page 5-7
■ Shafts	Page 8
■ Dissecting- and Grasping Forceps, Ø 10 mm	Page 9
■ Scissors/Biopsy, Forceps, Ø 5 mm	Page 10-11
■ Dissecting- and Grasping Forceps, Ø 5 mm	Page 11-18
■ Insert with Shaft, Ø 3 mm	Page 19
■ Clip and Ligatur, Ø 10 mm, Ø 5 mm, Ø 3 mm	Page 20
■ Cannulas, Fascial Closure, Knot Pusher	Page 21
■ Retractors	Page 22
■ Magnetic Balls – Trocar Sleeves/Silicone and Trumpet Valve	Page 23
■ Flap Valve – Trocar Sleeves	Page 24-25
■ Silicone Valve – Trocar Sleeves	Page 26
■ Flap Valve, Speculum	Page 27
■ Trocars	Page 28
■ Safety Trocars, Verres Needles	Page 29
■ Trocar Accessories	Page 30
■ Sealings	Page 31
■ Suction- and Irrigation	Page 32-33
■ HF-Monopolar Instruments	Page 34
■ Suction- and Irrigation, Accessories	Page 35
■ Bipolar Coagulation Instruments, Ø 5 mm, Ø 3 mm	Page 36-40
■ Bipolar Electrodes, Ø 5 mm, HF-Cables	Page 41
■ Insufflator ML-G	Page 42-43
■ Pump for Laparoscopy	Page 44
■ Morcellator & Accessories	Page 45-47

TELESCOPES

LAPALUX SHADOW-TELESCOPE II

Product

Order-No.

Description



429-62500

LAPALUX SHADOW-Telescope II

- Direction of view 30°
- Working length: 300 mm
- Connector for Storz/Wolf/ACMI light guide cables
- Sign colour: red

Ø 10 mm

This Patent Telescope creates Shadow

The shade gives more information especially in the depth of field.



Shadow Imaging

The unique design, utilising two light bundles, generates a three dimensional perception of the operating field. Improved orientation may increase work rate and safety.

High Resolution

The high quality optical system guarantees exceptional brightness and full illumination of the finest structures.

Autoclavability

As manufacturer we guarantee full autoclavability at 134 °C / 273 °F. All LAPALUX SHADOW-telescopes are manufactured from stainless steel.



Three-Dimensional Orientation

The surgeon is guaranteed a better three-dimensional orientation of the surgical field through the visualization of shadow (natural representation of the pictures).

Circle



Without Shade



Ball

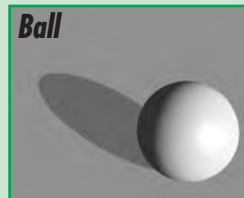

With Shade

Product

Order-No.

Description



429-62000

OP-Telescope

- Direction of view 0°
- Working length: 270 mm
- Connector for Storz/Wolf/ACMI
- Sign colour: green
- Working channel: Ø 6 mm

Ø 10 mm

TELESCOPES



TELESCOPES

Products

Order-No.

Description

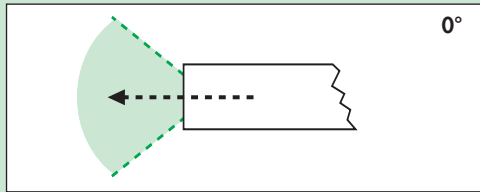

429-60050

LAPALUX-Telescope 0° HD

- Direction of view 0°
- Working length: 300 mm
- Connector for Storz/Wolf/ACMI
- Sign colour: green

429-60050 BA

- Working length: 510 mm

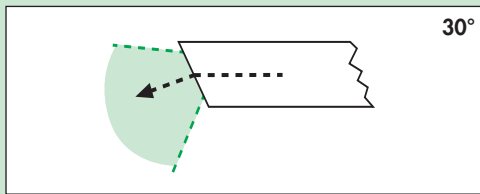

429-61050

LAPALUX-Telescope 30° HD

- Direction of view 30°
- Working length: 300 mm
- Connector for Storz/Wolf/ACMI
- Sign colour: red

429-61050 BA

- Working length: 510 mm

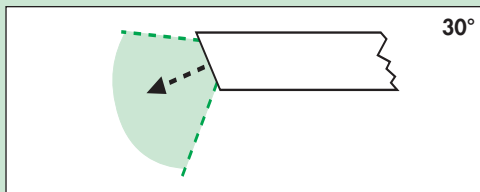

429-66000

LAPALUX-Telescope 30°

- Direction of view 30°
- Working length: 310 mm
- Connector for Storz/Wolf/ACMI
- Sign colour: red

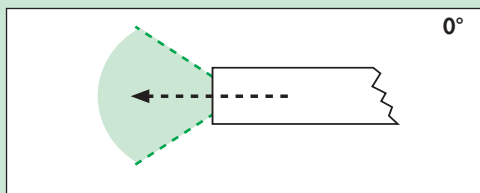

429-67050

LAPALUX-Telescope 0° HD

- Direction of view 0°
- Working length: 330 mm
- Connector for Storz/Wolf/ACMI
- Sign colour: green

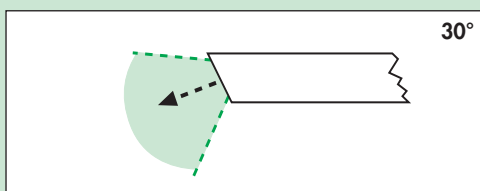

429-68050

LAPALUX-Telescope 30° HD

- Direction of view 30°
- Working length: 330 mm
- Connector for Storz/Wolf/ACMI
- Sign colour: red

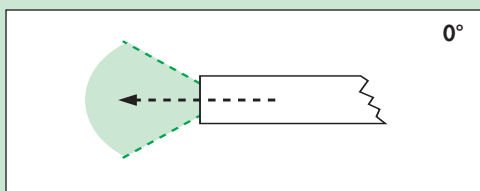

429-63000

LAPALUX-Telescope 0°

- Direction of view 0°
- Working length: 300 mm
- Connector for Storz/Wolf/ACMI
- Sign colour: green

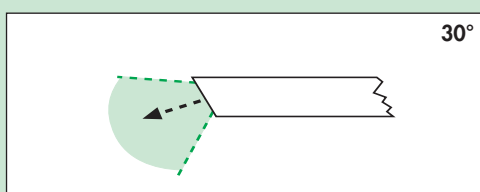

429-64000

LAPALUX-Telescope 30°

- Direction of view 30°
- Working length: 300 mm
- Connector for Storz/Wolf/ACMI
- Sign colour: red

Ø 10 mm

NEW

Ø 7 mm

Ø 5 mm

NEW

Ø 2.9 mm

HAND INSTRUMENTS FOR MIS

The New Hand Instrument consist of:

- Handle
- Shaft
- Insert

Advantages

- 1 Ergonomic developed handle for permanent exhaustless working
 - 2 Ergonomic warped handle-side
 - 3 Ergonomic optimised grip- and side-angle
 - 4 Soft and trapeze similar rounded grip radius avoid bruises
 - 5 Wedge-shaped finger-hollow adjusting wheel for optimal finger-contact with big or small hands
- Oval, rejuvenated fingerings support big as well as small hands
 - Light constructed handle
 - Compact and robust instrument
 - Ratched design for optimal processing
 - Autoclaveable and disassemble
 - Long-lasting materials
 - Exact and long-lasting

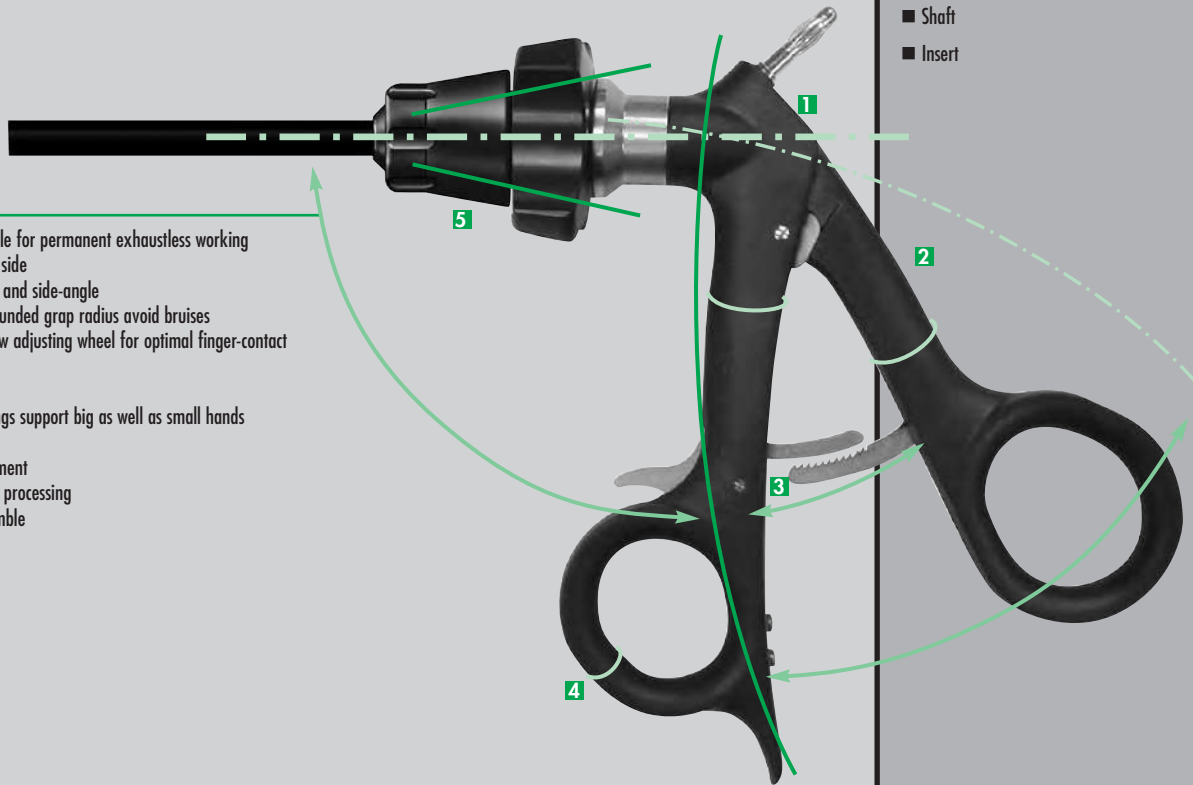

Instrument-Insert

- Wide range of instruments and cost-savings exchange in case of use up by **exchangeable** inserts for Ø 3 mm, Ø 5 mm and Ø 10 mm shafts.

Distal-Interface

- In this place, the insert can be screwed into the shaft.

Shafts

- For this hand instruments-system, isolated and metal shafts are available in diameter of Ø 5 mm and Ø 10 mm. Another advantage is that we have also shaft with Ø 10 mm outer diameter which is made for the Ø 5 mm inserts. Therefore, you will get a very robust instrument.

Proximal-Interface

- This interface is same by all handles and shafts; because of this, all inserts are able to be connected with the whole handle-spectrum through shaft knob.

Handles

- There are different handles to our system available and also with different kind of ratches.

Oblique HF-Connector

- For monopolar coagulation

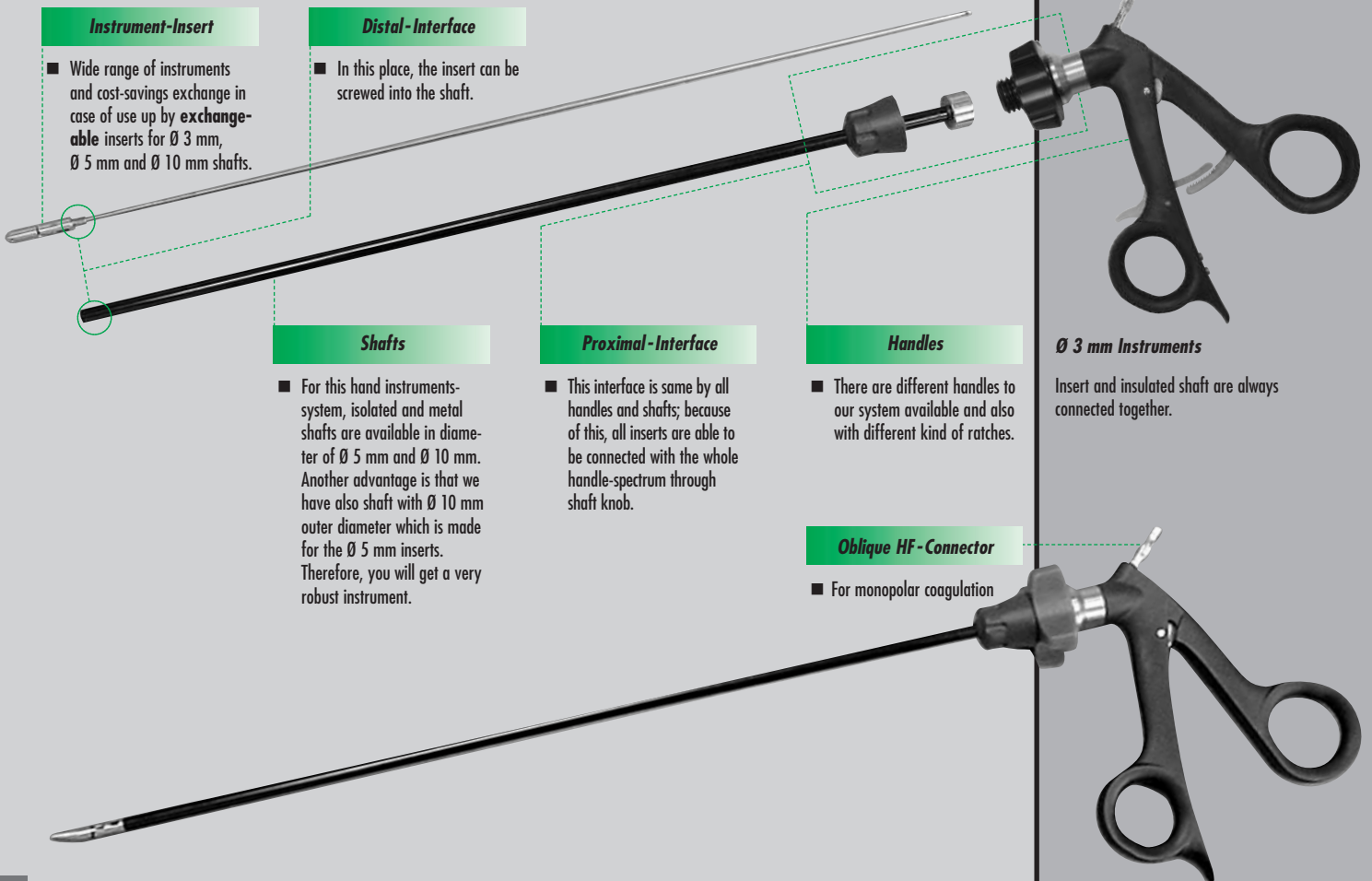

Ø 3 mm Instruments

Insert and insulated shaft are always connected together.

INTERFACE AND CONTROL



1.

Distal Interface

- The instrument-inserts are pushed right down into the shafts and screwed to the end.
Important: close the insert-mouth completely, because of impairment cutting!
- The distal interface is different between \varnothing 5 mm and \varnothing 10 mm instruments.



2.

Proximal Interface

- The insert should be closed now and the handle should be opened at the maximum. From now on, put the ball into the gap from an oblique position.
Close the handle and screw the shaft knob.

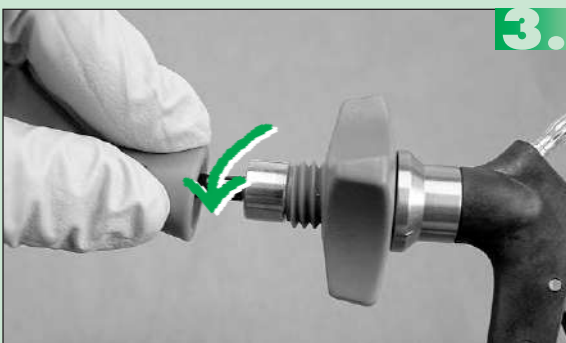

3.

Function Control

- Now, the instrument is completely assembled. Concluding, a function control is to be hold. It will be tested if a relaxed connection between handle and insert exists.

HANDLES

Products

Order-No.

Description



429-77015

**GRP-Laparoscopic Handle
Polymer**

- With HF-connection
- Fibre-reinforced



429-77030

**GRP-Laparoscopic Handle
Polymer with Ratchet**

- With HF-connection
- Fibre-reinforced



429-75003

Metal Handle



429-75002

Metal Handle with Ratchet

SHAFTS

Products

Order-No.

Description



429-75035

Metal Shaft with Shaft Knob

- Working length: 330 mm
- Ø 5 mm



429-75031

Metal Shaft with Shaft Knob

- Working length: 330 mm
- Ø 10 mm



429-75065
429-75065/22
429-75065/44

Insulated Shaft with Shaft Knob Ø 5 mm

- Working length: 330 mm
- Working length: 220 mm
- Working length: 440 mm



429-75062

Insulated Shaft with Shaft Knob

① Ø 10-5 mm

- Working length: 330 mm

Ø 10 mm

429-75061
429-75061/44

- Working length: 330 mm
- Working length: 440 mm

Attention ⓘ

Shaft outer-diameter Ø 10 mm:
for Ø 5 mm inserts

Shaft Knobs:

- For Ø 10 mm inserts separate delivery,
Order-No.: 429-75081
- For Ø 3-/Ø 5 mm inserts separate delivery,
Order-No.: 429-75085

INSERTS

DISSECTING- AND GRASPING FORCEPS

Inserts

Order-No.

Description

Ø 10 mm



429-75263

Spoon Grasping Forceps

- Single action

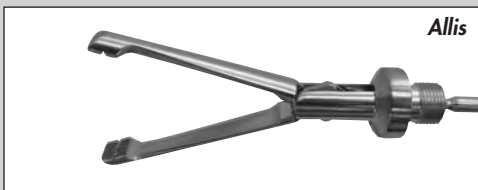

Allis

429-75215

Grasping Forceps

- Double action

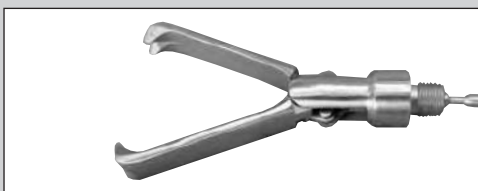

429-75281 (330 mm)
429-75281/44 (440 mm)

Claw Forceps

- 2 to 3 teeth
- Sharp
- Double action



Mixer

429-75165

Dissecting Forceps 90°

- Right-angled 90°
- Double action

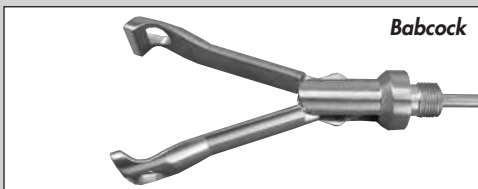

Babcock

429-75191

Grasping Forceps

- Double action



Maryland

429-75164

Grasping Forceps

- Slight curved
- Double action

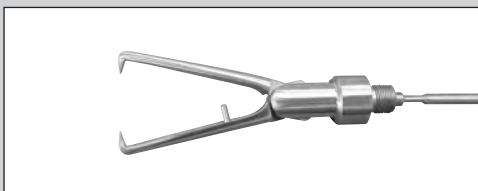

429-75282
429-75282/44

Tenaculum

INSERTS

SCISSORS/BIOPSY

Inserts

Order-No.

Description

Ø 5 mm

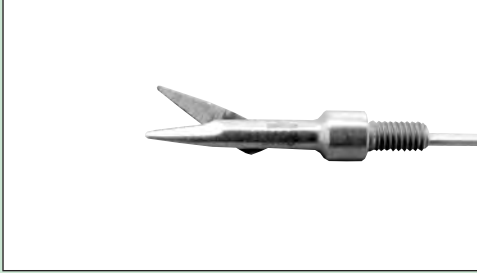

429-75301

Micro Scissors Straight

- Single action



429-75154

Endo Scissors

- Curved



429-75111

Peritoreal Scissors

- Straight
- Serrated jaw
- Single action



429-75261 (330 mm)
429-75261/22 (220 mm)
429-75261/44 (440 mm)

Hook Scissors

- Hardened
- Single action



Metzenbaum

429-75152

Scissors

- Straight
- Double action

INSERTS

SCISSORS/BIOPSY FORCEPS

Inserts

Order-No.

Description

Ø 5 mm

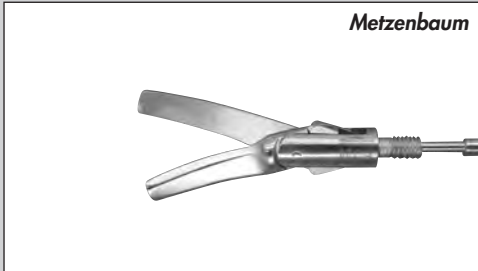

429-75153 (330 mm)
429-75153/22 (220 mm)
429-75153/44 (440 mm)

Scissors
■ Curved
■ Double action



Preparation Scissors
■ "Special-cut"
■ Curved
■ Double action



Scissors Heavy
■ Straight
■ Heavy blades



Biopsy Forceps
■ Single action



Biopsy Forceps
■ Single action

INSERTS

DISSECTING- AND GRASPING FORCEPS

Inserts

Order-No.

Description

Ø 5 mm



429-75274

Biopsy Forceps

- With pin
- Single action



429-75275

Biopsy Forceps

- Spoon jaw
- Double action

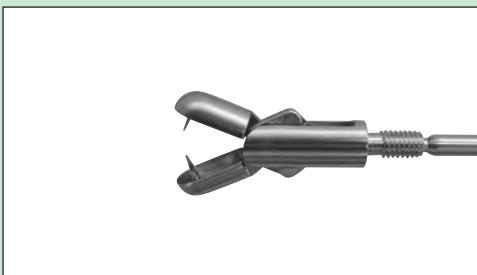

429-75272

Biopsy Forceps

- Spoon jaw with pin
- Double action



429-75238

Alligator Grasping- and Biopsy Forceps

- Double action



429-75121

Dissecting Forceps

- Slim
- Single action

INSERTS

DISSECTING- AND GRASPING FORCEPS

Inserts

Order-No.

Description

Ø 5 mm

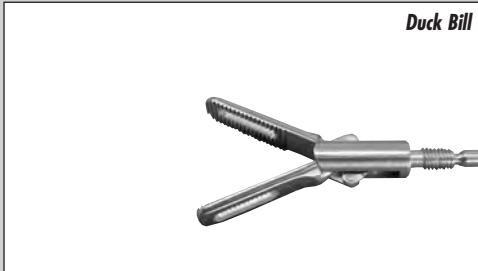

429-75237 (330 mm)
429-75237/22 (220 mm)
429-75237/44 (440 mm)

Dissecting- and Grasping Forceps

- Fenestrated
- Double action

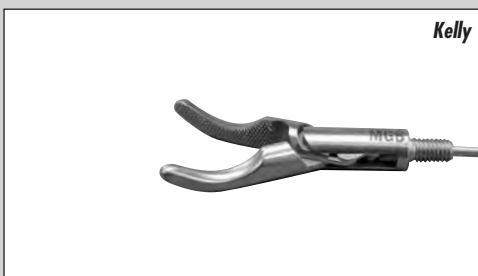

429-75166

Dissecting- and Grasping Forceps



429-75167

Dissecting- and Grasping Forceps



429-75214

Atraum. Grasping Forceps

- Taper off
- Single action



429-75175

Claw Forceps Aggressive

- 2 to 3 teeth
- Sharp
- Single action
- Second teeth raw

INSERTS

DISSECTING- AND GRASPING FORCEPS

Inserts

Order-No.

Description

Ø 5 mm



429-75171

Claw Forceps

- 2 to 3 teeth
- Sharp
- Single action



429-75232 (330 mm)
429-75232/22 (220 mm)
429-75232/44 (440 mm)

Dissecting- and Grasping Forceps

- Blunt
- Double action

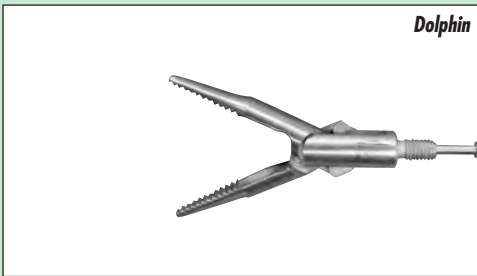

429-75201

Dissecting Forceps, Short

- With spoon
- Double action



429-75202

Dissecting Forceps, Long

- With spoon
- Double action

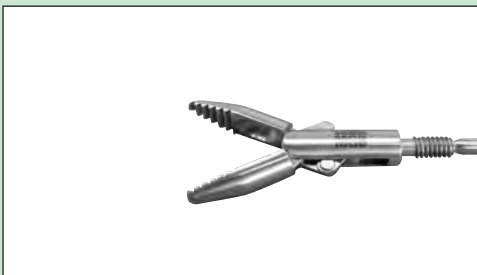

429-75203

Dissecting Forceps

- With spoon
- Pointed
- Double action

INSERTS

DISSECTING- AND GRASPING FORCEPS

Inserts

Order-No.

Description

Ø 5 mm



429-75204

Dissecting Forceps

- With spoon
- Blunt
- Double action



429-75291

Atraum. Grasping Forceps

- Slim
- Double action

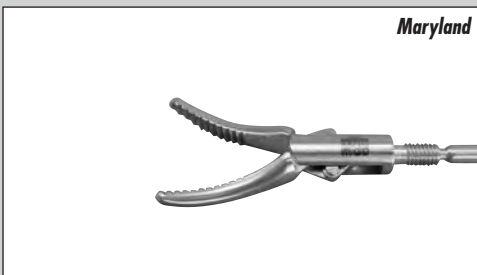

Maryland

429-75162 (330 mm)
429-75162/22 (220 mm)
429-75162/44 (440 mm)

Dissecting Forceps

- Short jaw
- Curved left
- Double action



Dorsey

429-75244

Intestinal Forceps

- Jaw length: 30 mm
- Double action
- Fenestrated



De Bakay

429-75222

Atraum. Intestinal Forceps

- Jaw length: 30 mm
- Double action

429-75223

- Jaw length: 60 mm

INSERTS

DISSECTING- AND GRASPING FORCEPS

Inserts

Order-No.

Description

Ø 5 mm



429-75231

Dissecting- and Grasping Forceps

- Short
- Double action

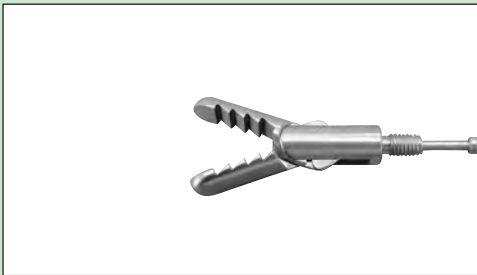

429-75236

Alligator Grasping Forceps

- Double action

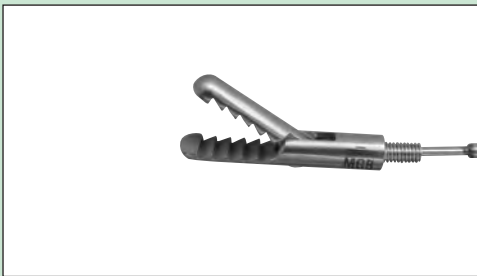

429-75241

Alligator Grasping Forceps

- Single action



Cobra

429-75131

Grasping Forceps

- 2 to 3 teeth
- Hardened
- Double action

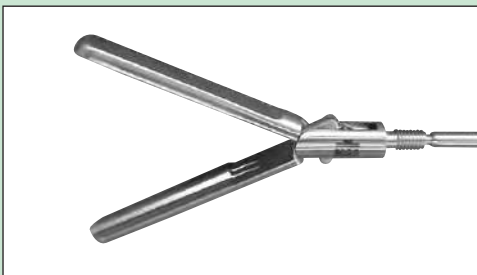

429-75221

Atraum. Grasping Forceps

- Double action

INSERTS

DISSECTING - AND GRASPING FORCEPS

Inserts

Order-No.

Description

Ø 5 mm



429-75234 (330 mm)
429-75234/22 (220 mm)
429-75234/44 (440 mm)

Grasping Forceps

- Fenestrated
- Double action



429-75242

Endo Grasper

- Fenestrated
- Double action



429-75235 (330 mm)
429-75235/22 (220 mm)
429-75235/44 (440 mm)

Grasping Forceps

- Double action



429-75211

Atraum. Grasping Forceps

- Double action



429-75183

Bowel Grasping Forceps

- Double action

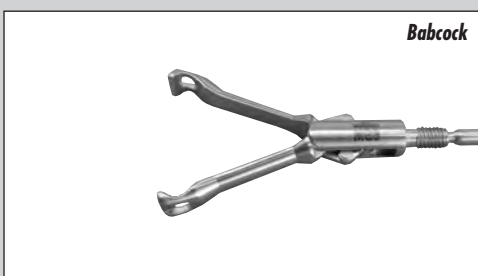

429-75208

Grasping Forceps

INSERTS

DISSECTING - AND GRASPING FORCEPS

Inserts

Order-No.

Description

Ø 5 mm



429-75245

Micro Grasping Forceps



429-75240

Atraum. Grasping Forceps

- Wavy teeth

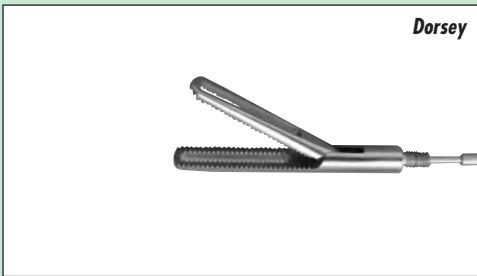

429-75239

Grasping Forceps

- Fenestrated
- Single action

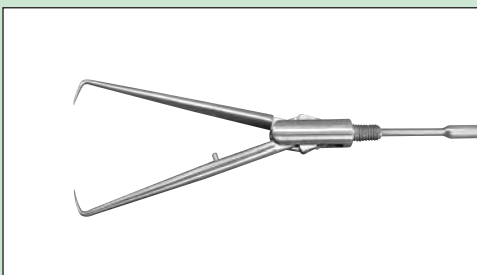

429-75283

Insert Tenaculum

- Ø 5 mm for 330 mm shafts

429-75283/44

- Ø 5 mm for 440 mm shafts

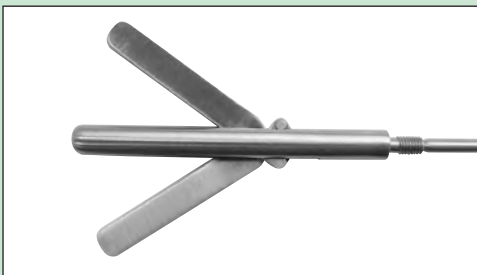

429-75305

Retractor Insert with 3 Fingers

INSERT WITH SHAFT

Inserts

Order-No.

Description

Ø 3 mm



429-73411

Scissors

- Irrigation port

- Working length: 330 mm



429-73421

Biopsy Forceps

- Irrigation port



429-73381

Grasping Forceps

- Straight
- Serrated
- Irrigation port



429-73391

Grasping Forceps

- Curved
- Serrated
- Irrigation port



429-73401

Atraum. Grasping Forceps

Ø 3 mm Instruments

Inserts and insulated shafts are always connected together.

CLIP AND LIGATUR

Products

Order-No.

Description

Ø 10 mm/Ø 5 mm/Ø 3 mm

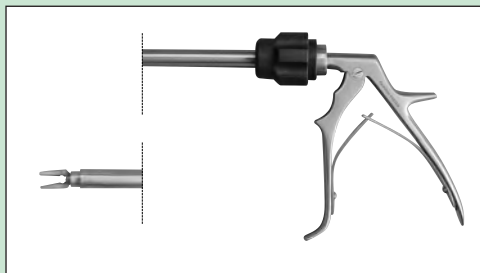

429-70370

Clip-Applicator

- For SLS-Clips
- Medium-large
- Rotable
- Disassemble

429-70379

SLS Titan Clip

- Medium-large
- Box with 20 cartridges with 6 clips

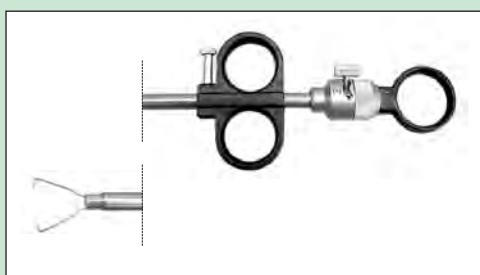

429-70380

Ring-Applicator

- Ø 6.5 mm
- Length: 287 mm

429-70382

Ring-Applicator

- Ø 6.0 mm
- Length: 350 mm
- For OP-Laparoscope
- Order-Nr.: 429-62000

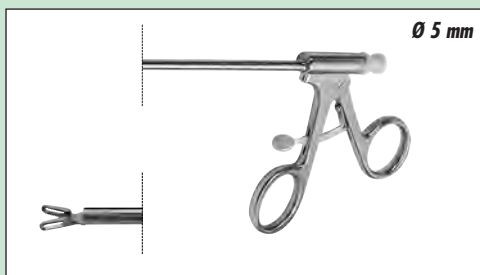

Ø 5 mm

429-70305

Cholangiogram Clamp

- Ø 5 mm
- Channel for cholangiocatheter
- Handle with ratchet
- Assemble
- 6 Fr. Channel

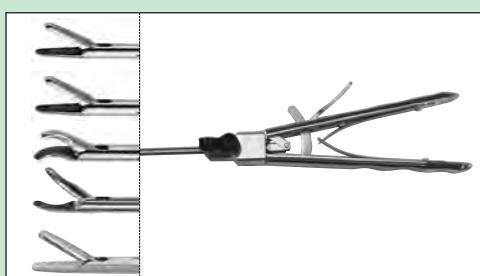

429-73430 (Ø 3 mm)

429-75310 (Ø 5 mm)

429-75350 (Ø 5 mm)

429-75340 (Ø 5 mm)

429-75360 (Ø 5 mm)

Axial Needle Holder with Rinsing Channel

- Not detachable
- Straight
- Straight
- Left
- Right
- Straight convex/concav shaped

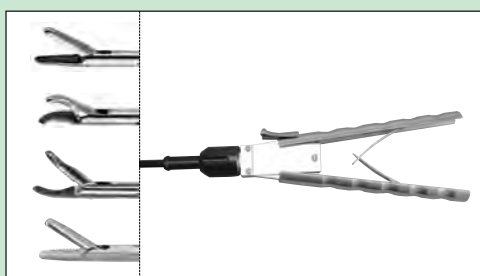

429-77310

429-77350

429-77340

429-77360

Needle Holder in 3 Components

- Disassemble
- Straight
- Left
- Right
- Straight convex/concav shaped

Tungsten Carbide

CANNULAS

Products

Order-No.

Description

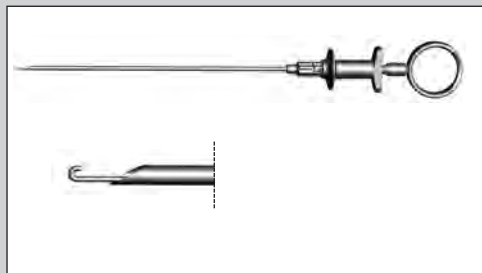

429-23810

Fascial Closure Device

- Ø 2.3 mm
- Working length: 140 mm

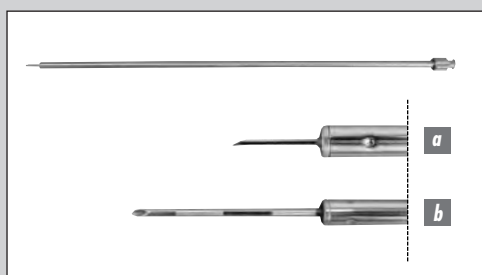

a 429-14530

a Puncture Cannula

- Ø 5 mm
- Needle diameter: 1.0 mm
- Working length: 300 mm

b 429-14520

b Puncture Cannula

- Ø 5 mm
- Needle diameter: 1.5 mm
- Working length: 300 mm



429-16730

Probe Rod

- Graduated
- Diameter: Ø 5 mm
- Working length: 300 mm

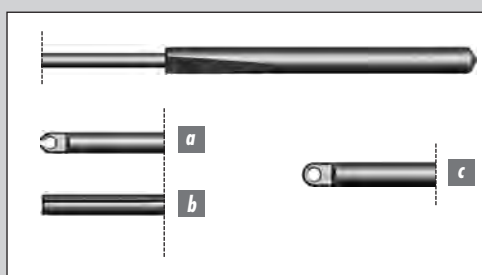

a 429-40270

Knot Pusher

- Ø 4 mm
- Working length: 330 mm

b 429-40271

a ■ Open loop

c 429-40272

b ■ Slot

c ■ Closed loop

INSTRUMENTS

RETRACTORS

Products

Order-No.

Description



429-16905

„Fan“ Retractor with 3 Fingers

- Diameter: 5 mm
- Working length: 340 mm



429-16901

„Fan“ Retractor with 5 Fingers

- Diameter: 10 mm
- Working length: 380 mm



429-16915

„Fan“ Retractor with 3 Fingers

- Diameter: 10 mm
- Working length: 340 mm
- Vertical up to 50° adjustable



429-16911

„Fan“ Retractor with 5 Fingers

- Diameter: 10 mm
- Working length: 380 mm
- Vertical up to 50° adjustable

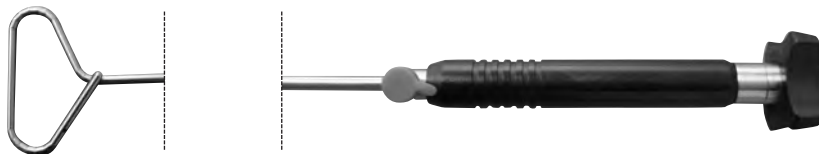

429-16925

Flex Retractor

- Diameter: 5 mm
- With irrigation port

MAGNETIC BALL – TROCAR SLEEVES

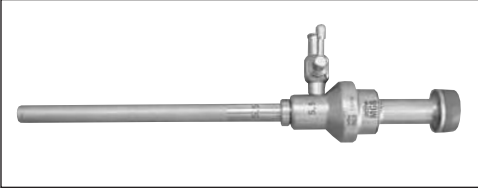
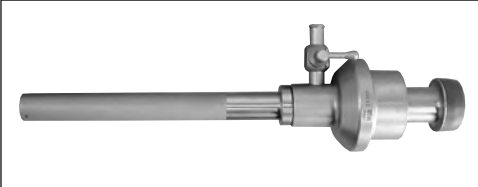

Products	With Luer Stopcock Order-No.	Diameter	Working Length	Description
	429-24055	5.5 mm	95.0 mm	Trocar Sleeve with Magnetic Ball ■ Stainless steel
	429-24100	10.0 mm	97.0 mm	Trocar Sleeve with Magnetic Ball ■ Stainless steel

SILICONE VALVE TROCAR-SLEEVE

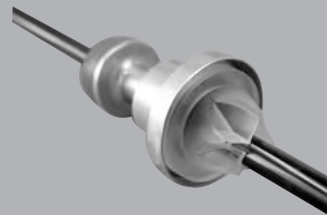

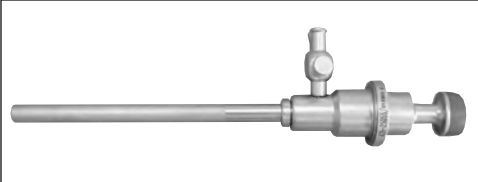
Products	With Luer Stopcock Order-No.	Diameter	Working Length	Description
	429-25055	5.5 mm	95.0 mm	Trocar Sleeve with Silicone Valve ■ Stainless steel

TRUMPET VALVE – TROCAR SLEEVE



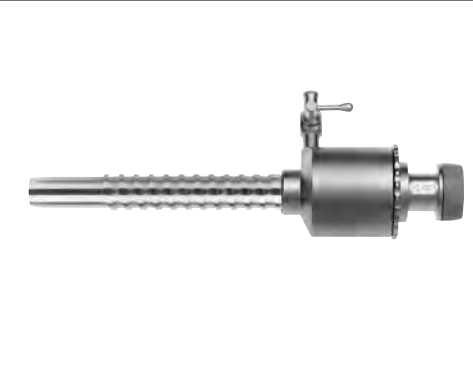
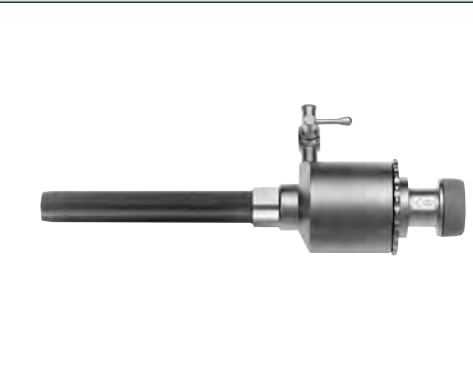
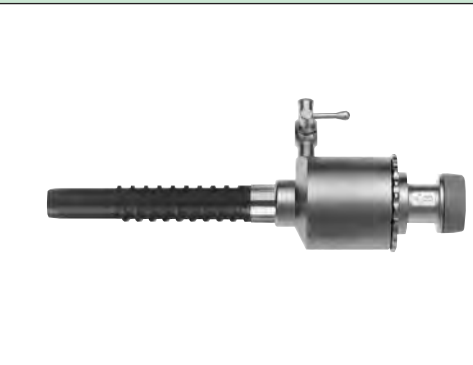

Products	With Luer Stopcock Order-No.	Diameter	Working Length	Description
	429-40005	5.5 mm	95.0 mm	Metal Shaft ■ Straight
	429-40013	10.0 mm	97.0 mm	
	429-40014	11.0 mm	101.0 mm	

FLAP VALVE – TROCAR SLEEVES

Products	With Luer Stopcock	Diameter	Working Length	Description
	Order-No.			
	429-40201	3.5 mm	70.0 mm	Metal Shaft
	429-45201	5.0 mm	92.0 mm	■ Straight
	429-40001	5.5 mm	95.0 mm	
	429-40004	7.0 mm	95.0 mm	
	429-45001	10.0 mm	97.0 mm	
	429-40002	11.0 mm	101.0 mm	
	429-40003	12.5 mm	98.0 mm	
	429-40011	5.5 mm	95.0 mm	Metal Shaft
	429-40012	11.0 mm	101.0 mm	■ With retaining thread
	429-41012	12.5 mm	98.0 mm	
	429-40051	5.5 mm	95.0 mm	Plastic Shaft
	429-40052	11.0 mm	101.0 mm	■ Straight
	429-40054	12.5 mm	98.0 mm	
	429-40061	5.5 mm	95.0 mm	Plastic Shaft
	429-40062	11.0 mm	101.0 mm	■ With retaining thread
	429-40064	12.5 mm	98.0 mm	





FLAP VALVE – TROCAR SLEEVES

Products	With Luer Stopcock	Diameter	Working Length	Description
	Order-No.			
	429-40202	3.5 mm	70.0 mm	Metal Shaft
	429-40020	5.0 mm	92.0 mm	■ Straight
	429-40021	5.5 mm	95.0 mm	■ With manual opening
	429-40025	10.0 mm	97.0 mm	
	429-40022	11.0 mm	101.0 mm	
	429-40024	12.5 mm	98.0 mm	
	429-40021/15	5.5 mm	150.0 mm	
	429-40022/15	11.0 mm	150.0 mm	Bariatric Surgery
	429-40024/15	12.5 mm	150.0 mm	
	429-40031	5.5 mm	95.0 mm	Metal Shaft
	429-40032	11.0 mm	101.0 mm	■ With retaining thread
	429-40034	12.5 mm	98.0 mm	■ With manual opening
	429-40071	5.5 mm	95.0 mm	Plastic Shaft
	429-40072	11.0 mm	101.0 mm	■ Straight
	429-40074	12.5 mm	98.0 mm	■ With manual opening
	429-40081	5.5 mm	95.0 mm	Plastic Shaft
	429-40082	11.0 mm	101.0 mm	■ With retaining thread
	429-40084	12.5 mm	98.0 mm	■ With manual opening

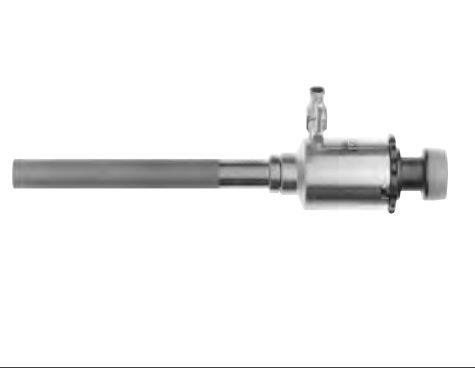

Stainless Steel

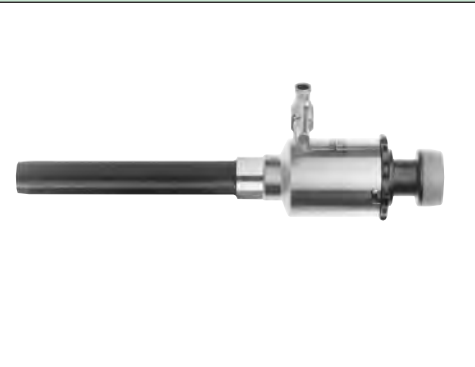
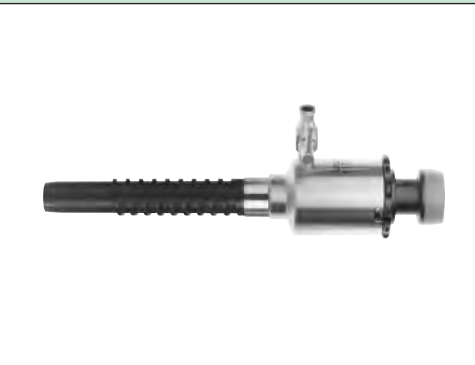
SILICONE VALVE – TROCAR SLEEVES

Products	With	Diameter	Working Length	Description
	Luer Stopcock			
	Order-No.			
	429-40280	3.5 mm	70.0 mm	Metal Shaft
	429-40281	5.0 mm	92.0 mm	■ Straight
	429-40282	5.5 mm	95.0 mm	
	429-40283	10.0 mm	97.0 mm	
	429-40284	11.0 mm	101.0 mm	
	429-40285	12.5 mm	98.0 mm	
	429-40306	5.5 mm	95.0 mm	Metal Shaft
	429-40308	11.0 mm	101.0 mm	■ With retaining thread
	429-40309	12.5 mm	98.0 mm	
	429-40311	5.5 mm	95.0 mm	Plastic Shaft
	429-40313	11.0 mm	101.0 mm	■ Straight
	429-40314	12.5 mm	98.0 mm	
	429-40321	5.5 mm	95.0 mm	Plastic Shaft
	429-40323	11.0 mm	101.0 mm	■ With retaining thread
	429-40324	12.5 mm	98.0 mm	

TROCARS

BIG DIAMETER FLAP VALVE – TROCAR SLEEVES WITH MANUAL OPENING

Products	With Luer Stopcock	Diameter	Working Length	Description
	Order-No.			
	429-40041	15.0 mm	110.0 mm	Metal Shaft
	429-40042	20.0 mm	120.0 mm	<input checked="" type="checkbox"/> Straight Stainless Steel
	429-23900			Abdominal Speculum



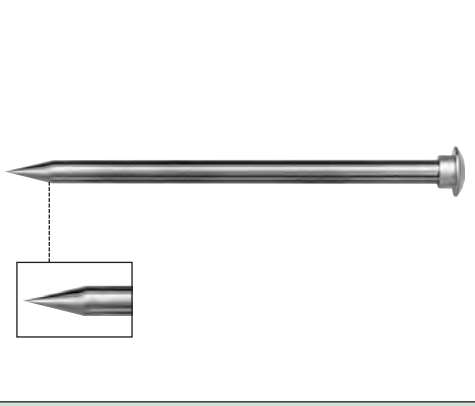
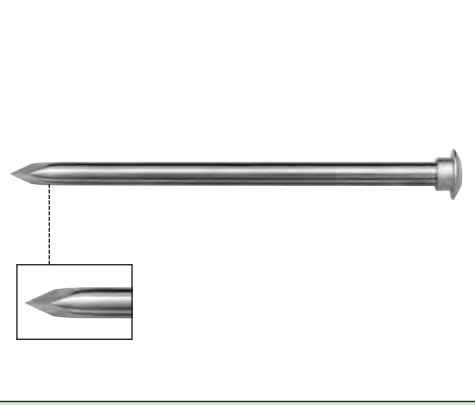
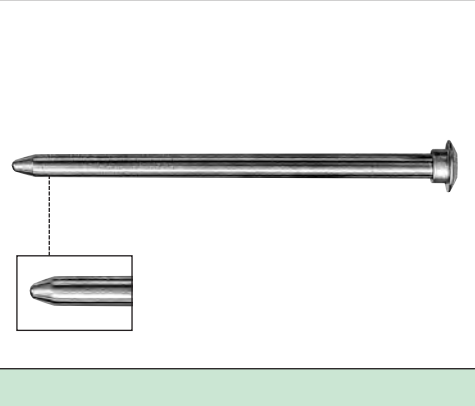
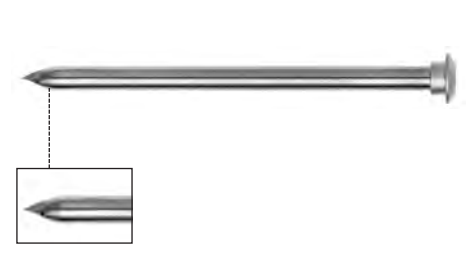

TROCARS

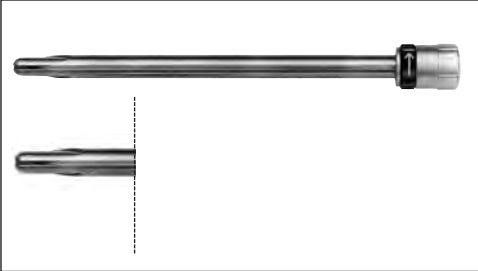
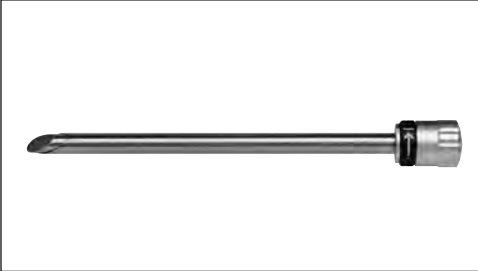
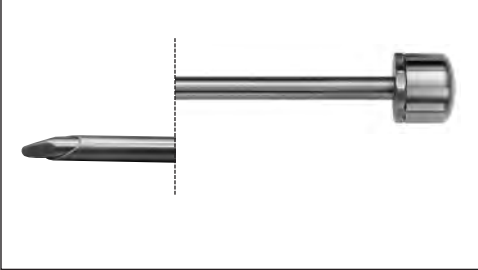
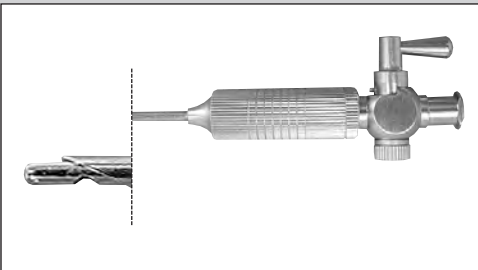
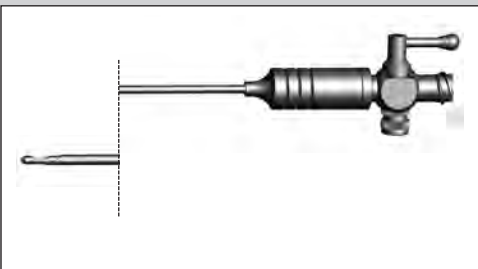
Products	Order-No.	Diameter	For Sleeve Working Length	Description
	429-40203	3.5 mm	70.0 mm	Trocar
	429-40130	5.0 mm	92.0 mm	■ Conical
	429-40131	5.5 mm	95.0 mm	
	429-40170	7.0 mm	95.0 mm	
	429-40134	10.0 mm	97.0 mm	
	429-40133	11.0 mm	101.0 mm	
	429-40137	12.5 mm	98.0 mm	
	429-40131/15	5.5 mm	150.0 mm	
	429-40133/15	11.0 mm	150.0 mm	Bariatric Surgery
	429-40137/15	12.5 mm	150.0 mm	
	429-40204	3.5 mm	70.0 mm	Trocar
	429-40136	5.0 mm	92.0 mm	■ Pyramidal
	429-40141	5.5 mm	95.0 mm	
	429-40159	7.0 mm	95.0 mm	
	429-40138	10.0 mm	97.0 mm	
	429-40143	11.0 mm	101.0 mm	
	429-40139	12.5 mm	98.0 mm	
	429-40141/15	5.5 mm	150.0 mm	
	429-40143/15	11.0 mm	150.0 mm	Bariatric Surgery
	429-40139/15	12.5 mm	150.0 mm	
	429-40146	3.5 mm	70.0 mm	Trocar
	429-40147	5.0 mm	92.0 mm	■ Conical blunt
	429-40148	5.5 mm	95.0 mm	
	429-40160	7.0 mm	95.0 mm	
	429-40149	10.0 mm	97.0 mm	
	429-40151	11.0 mm	101.0 mm	
	429-40152	12.5 mm	98.0 mm	
	429-40153	5.0 mm	92.0 mm	Trocar
	429-40154	5.5 mm	95.0 mm	■ Pyramidal with hollow grinding
	429-40163	7.0 mm	95.0 mm	
	429-40135	10.0 mm	97.0 mm	
	429-40156	11.0 mm	101.0 mm	
	429-40155	12.5 mm	98.0 mm	

SAFETY TROCARS

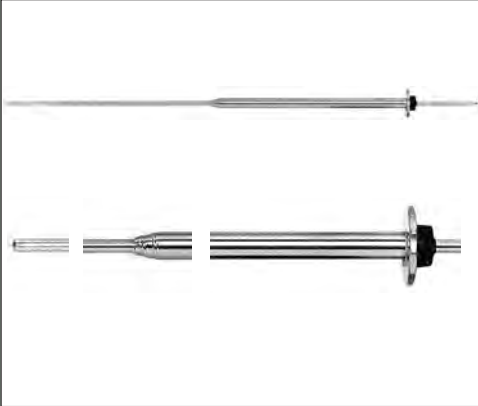
Products	Order-No.	Diameter	For Sleeve Working Length	Description
	Order-No.			
	429-40103	5.0 mm	92.0 mm	Trocar
	429-40101	5.5 mm	95.0 mm	■ Pyramidal
	429-40104	10.0 mm	97.0 mm	
	429-40102	11.0 mm	101.0 mm	
	429-40105	12.5 mm	98.0 mm	
	429-40113	5.0 mm	92.0 mm	Trocar
	429-40111	5.5 mm	95.0 mm	■ Half-moon
	429-40114	10.0 mm	97.0 mm	
	429-40112	11.0 mm	101.0 mm	
	429-40115	12.5 mm	98.0 mm	
	429-40125	5.5 mm	95.0 mm	Trocar
	429-40126	10.0 mm	97.0 mm	■ V-style
	429-40127	11.0 mm	101.0 mm	
	670-95341 (100 mm)			Verres Needle
	670-95342 (120 mm)			Ø 2 mm
	670-95340 (150 mm)			
	670-95351 (100 mm)			Verres Needle
	670-95352 (120 mm)			Ø 2 mm
	670-95350 (150 mm)			Stainless Steel





TROCAR ACCESSORIES

Products	Order-No.	Diameter	Description	
	429-23210	5.0 mm - 10.0 mm	Dilatation Sleeve with Rod	
	429-23211	5.0 mm - 11.0 mm		
	429-23212	11.0 mm - 15.0 mm		
	429-23213	10.0 mm - 15.0 mm		
	429-23214	5.0 mm - 15.0 mm		
	429-23215	11.0 mm - 20.0 mm		
	429-23216	10.0 mm - 20.0 mm		
	429-23217	5.0 mm - 20.0 mm		
	429-23011	10.0 mm - 5.5 mm	Reduction Sleeve	
	429-40150	11.0 mm - 5.5 mm		
	429-23013	12.5 mm - 10.0 mm		
	429-23014	12.5 mm - 5.5 mm		
	429-16600	5.0 mm - 4.0 mm		Applicator for Endo-Ligatur
	429-23510	5.0 mm	Trocar Stop ■ 35.0 mm	
	429-23511	5.5 mm		
	429-23512	10.0 mm		
	429-23513	11.0 mm		
	429-23514	12.5 mm		
	429-23115	10.0 mm - 5.5 mm	Reducer with Silicone Strap	
	429-23116	11.0 mm - 5.5 mm		
	429-23117	12.5 mm - 5.5 mm		
	429-23118	12.5 mm - 10.0 mm		
	429-23119	12.5 mm/11.0 mm/10.0 mm to 5,5 mm	Slide Reducer	
	429-23120	12.5 mm to 10.0 mm		

Reduction Sleeve

- Order-No.:
429-23015 (15.0 mm - 10.0 mm)
429-23016 (15.0 mm - 5.50 mm)
429-23017 (20.0 mm - 10.0 mm)
429-23018 (20.0 mm - 5.50 mm)

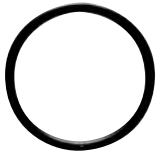
SEALINGS

Products	Order-No.	Diameter	Description
	Order-No.		
	429-90023 (10 pcs.)	3.0 mm/3.5 mm	Sealing Caps ■ For all trocar sleeves
	429-90001 (10 pcs.)	5.0 mm/5.5 mm	
	429-90022 (2 pcs.)	10.0 mm/10.5 mm/11.0 mm	
	429-90027 (10 pcs.)	12.5 mm	
	429-90021 (2 pcs.)	15.0 mm	
	429-90020 (2 pcs.)	20.0 mm	
	429-90030	3.0 mm/3.5 mm	Seal (1 pcs.) ■ For trocar sleeves on page 25/26
	429-90032	5.0 mm/5.5 mm	
	429-90034	10.0 mm/11.0 mm/12.5 mm	
	429-90037	15.0 mm	
	429-90038	20.0 mm	
	429-90040	3.0 mm/3.5 mm	O-Ring (1 pcs.) ■ For flap valve trocar sleeves on page 25/26
	429-90042	5.0 mm/5.5 mm	
	429-90044	10.0 mm/11.0 mm/12.5 mm	
	429-90047	15.0 mm	
	429-90048	20.0 mm	
	429-90017 (5 pcs.)	3.5 mm/5.5 mm	Silicone Valve ■ For trocar sleeves on page 27
	429-90018 (5 pcs.)	10.0 mm/12.5 mm	
	429-90019 (10 pcs.)		Silicone Valve ■ For Order-No.: 429-25055

SUCTION- AND IRRIGATION

Products

Order-No.

Description

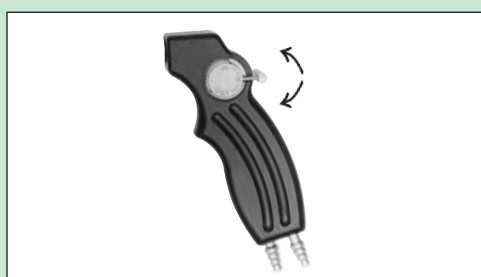
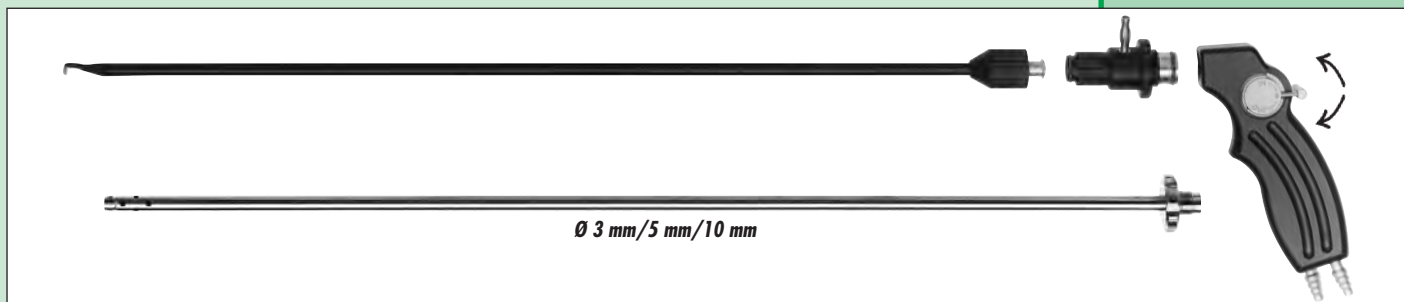

429-80040

Suction-/Irrigation-Handle

- Ergonomic handle
- Slight swivelling
- 2 ways slide-valve
- Tube connections

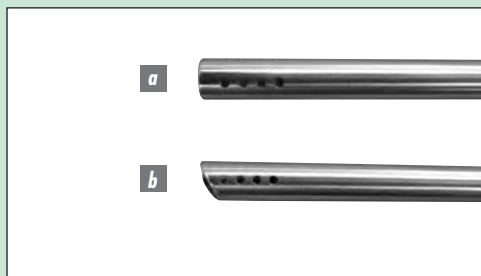

429-80044

a 429-80042

b 429-80038

429-80043

Suction-/Irrigation Tubes for Handle (Order-No. 429-80040)

- Working length: 330 mm
- Tube Ø 3 mm
- a** ■ Tube Ø 5 mm
- b** ■ Tube Ø 5 mm distal oblique for magnetic trocars
- Tube Ø 10 mm



429-80041

HF-Electrode-Adapter for Handle (Order-No. 429-80040)

- 360° rotatable

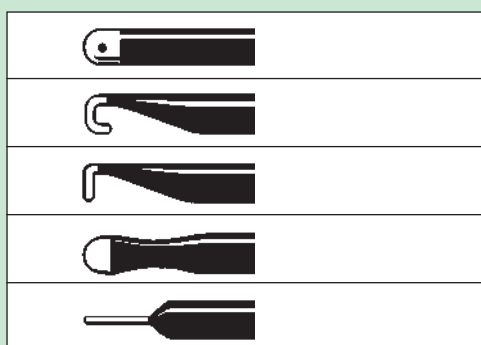

429-80045

429-80046

429-80047

429-80048

429-80049

Electrodes with Channel

- Working length: 330 mm
- Button electrode
- J- Hook electrode
- L- Hook electrode
- Spatula electrode
- Needle electrode

SUCTION- AND IRRIGATION

Products

Order-No.

Description



429-80035

Standard Suction-/Irrigation Pistol Handle

- Connection M8 x 1



429-80039

Suction-/Irrigation Handle

- Ø 5 mm
- With sliding valve and tube connection
- Connection M8 x 1



429-80034

Suction-/Irrigation Tube for M8 x 1

- Working length: 330 mm

429-80032

- Tube Ø 3 mm

429-80033

- Tube Ø 5 mm

- Tube Ø 10 mm



429-80036

Suction-/Irrigation Tube for M8 x 1

- Working length: 330 mm
- Tube Ø 5 mm distal oblique for magnetic trocars

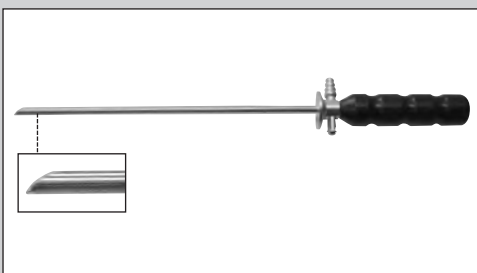

670-96330

Irrigation Trocar for Glass Bottle

670-96331

- 0.5 l

- 1.0 l

INSTRUMENTS

HF-MONOPOLAR INSTRUMENTS

Products

Order-No.

Description

Order-No.

Description

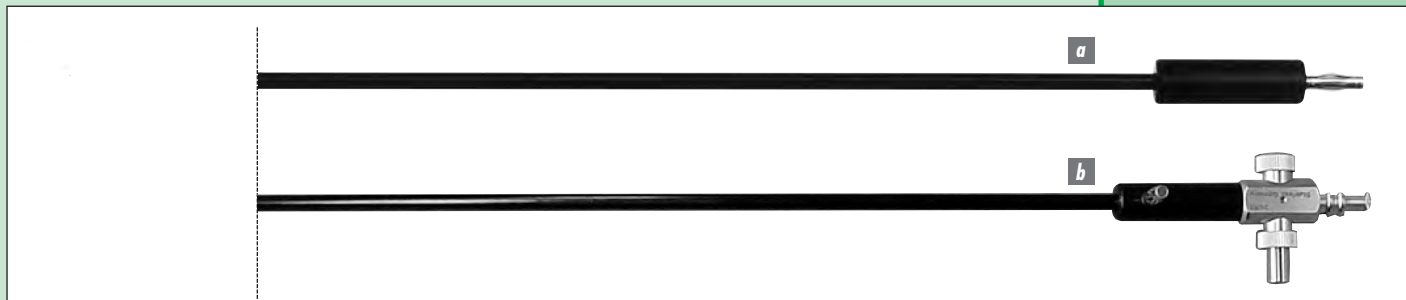

Monopolar Standard Electrodes without Channel

■ Working length: 330 mm

Monopolar Electrodes with Trumpet Valve

■ Working length: 330 mm

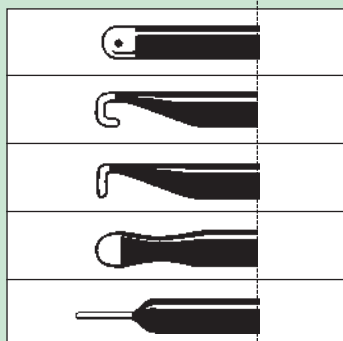

a 429-80061

a Button electrode

b 429-80001

b Button electrode

a 429-80062

a J- Hook electrode

b 429-80004

b J- Hook electrode

a 429-80063

a L- Hook electrode

b 429-80003

b L- Hook electrode

a 429-80064

a Spatula electrode

b 429-80002

b Spatula electrode

a 429-80065

a Needle electrode

b 429-80025

b Needle electrode

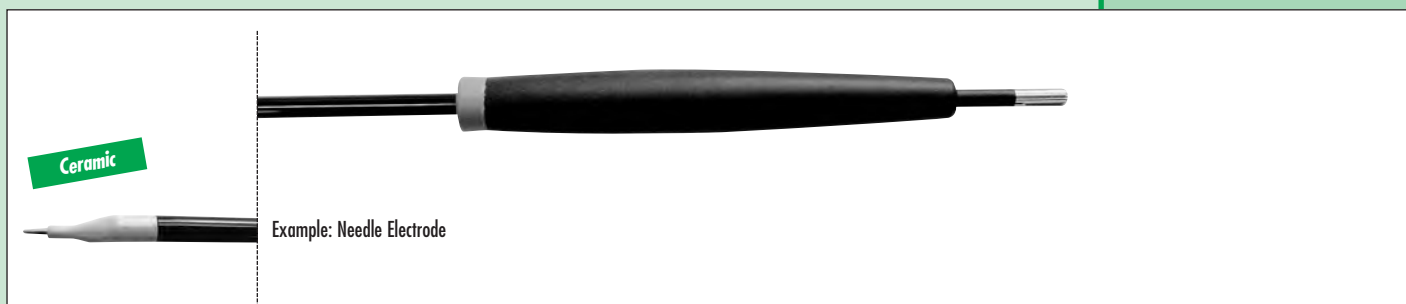

Monopolar Standard Electrodes without Channel

■ Working length: 330 mm

Ceramic

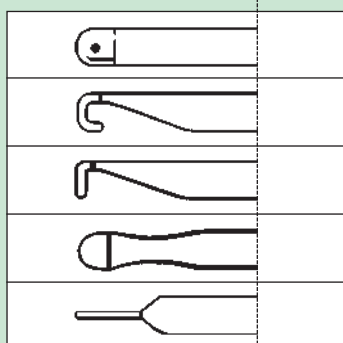

■ 429-80071

■ Button electrode

■ 429-80072

■ J- Hook electrode

■ 429-80073

■ L- Hook electrode

■ 429-80074

■ Spatula electrode

■ 429-80075

■ Needle electrode

ACCESSORIES

Products

Order-No.

Description



429-80050

Suction- Irrigation-Handle

- Large tube connector
- Sidewise Luer-Lock connection

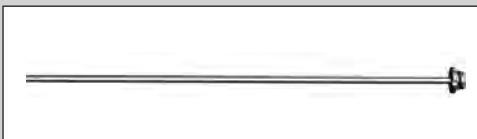

429-80051

Suction- Irrigation-Tube Ø 5 mm

- Working Length: 330 mm
- For Order-No.: 429-80050

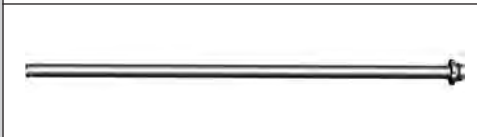

429-80052

Suction- Irrigation-Tube Ø 10 mm

- Working Length: 330 mm
- For Order-No.: 429-80050

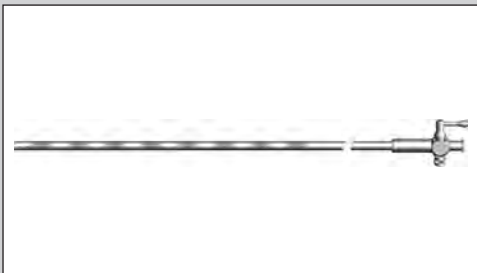

429-80055

Suction- Irrigation-Cannula Ø 5 mm

- Ø 5 mm
- Working Length: 330 mm
- Luer connection
- Stop cock



670-91320

Connection Cable for Disposable Neutral Electrodes

- 5 m

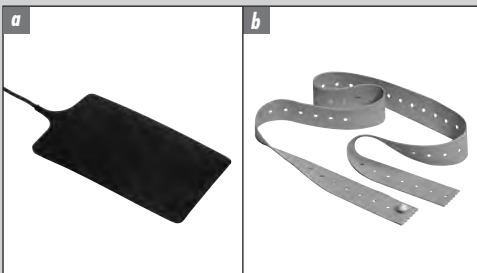

a 670-91313

a Neutral Electrode

- Reusable

b 670-91311

b Rubber Band

- For reusable neutral electrodes
- 1 m

BIPOLAR

BIPOLAR COAGULATION INSTRUMENTS

Ø 5 mm

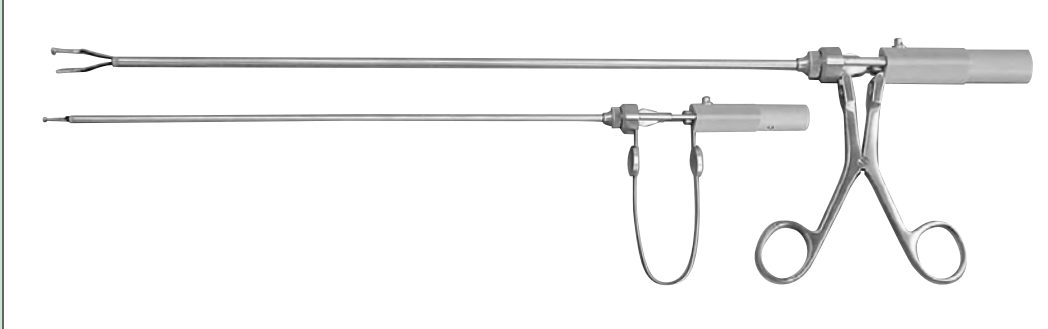

Products

Order-No.

Description

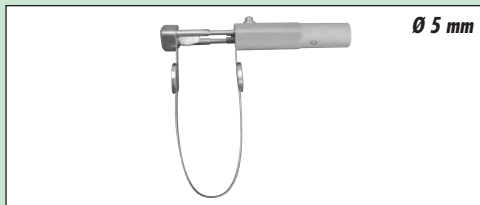

429-70050
(Picture)

Spring Handle
■ Standard plug

670-91338

**Connection Cable for
Bipolar Tweezers**



429-70060

Scissors Handle
■ Standard plug



429-70070

Shaft
■ Stainless steel

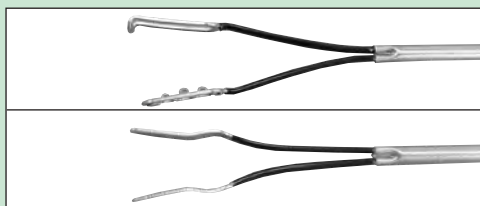

429-70071

**Tubal Coagulation Forceps
Electrode**

■ Width: 4.5 mm

429-70072

Plate Electrode

■ Width: 3.0 mm

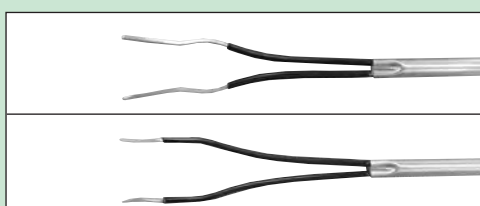

429-70073

Tweezers Electrode

■ Width: 1.5 mm
■ With short isolation

429-70074

Tweezers Electrode

■ Width: 1.5 mm
■ With long isolation

BIPOLAR

BIPOLAR COAGULATION INSTRUMENTS

Products

Order-No.

Description

Ø 5 mm

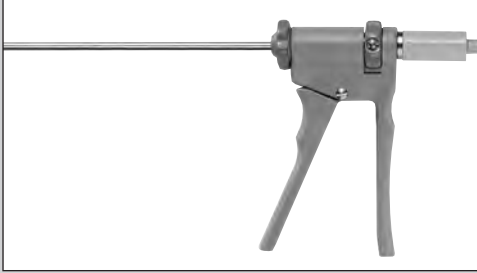

429-81005

Coagulation Forceps with Standard Handle

- 360° rotatable
- Max. output: 60 W
- Working length: 340 mm
- Detachable
- Inclusive shaft

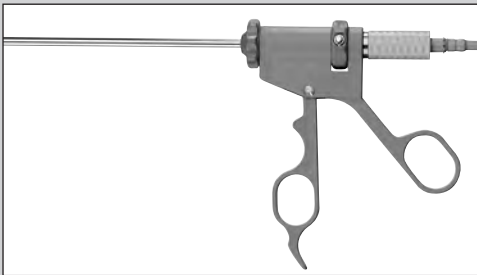

429-81023

Coagulation Forceps with Ring Handle

- 360° rotatable
- Max. output: 60 W
- Working length: 340 mm
- Detachable
- Inclusive shaft

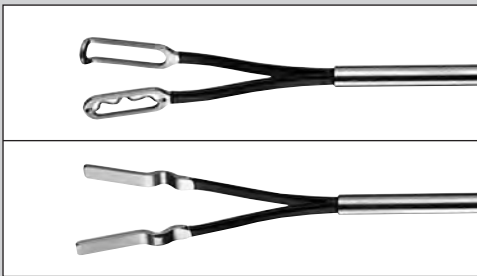

429-81007

Tubal Coagulation Forceps Electrode

- Rippled bar

429-81008

Plate Electrode

- Tong-type bit: 3 mm

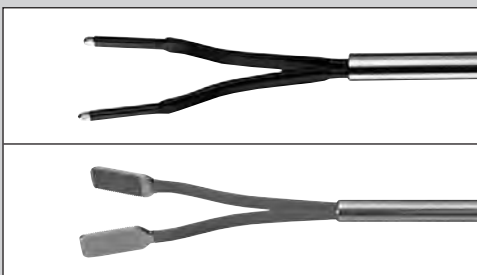

429-81011

Tweezers Electrode

- Tweezers tip: 1 mm

429-81024

Kleppinger Electrode

- Serrated



429-81025

Maryland Dissector

- Curved

BIPOLAR COAGULATION INSTRUMENTS

Products

Order-No.

Description

Ø 5 mm



429-81015

Scissors Electrode with TC Blade
 ■ Curved



429-81026

Scissors Electrode
 ■ Curved

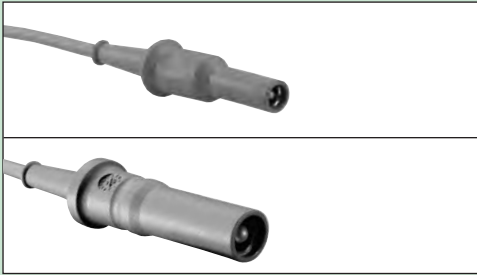

429-81010

Bipolar Connection Cable
 ■ To Martin-, Berchtold-units
 ■ For Order-No.: 429-81005, 429-81023

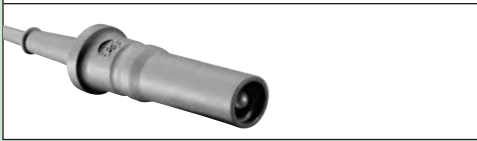

429-81021

Bipolar Connection Cable
 ■ To Erbe-units
 ■ For Order-No.: 429-81005, 429-81023



429-81019

Bipolar Connection Cable
 ■ To MGB-units
 ■ For Order-No.: 429-81005, 429-81023



429-81020

Bipolar Connection Cable
 ■ To Valleylab-units
 ■ For Order-No.: 429-81005, 429-81023

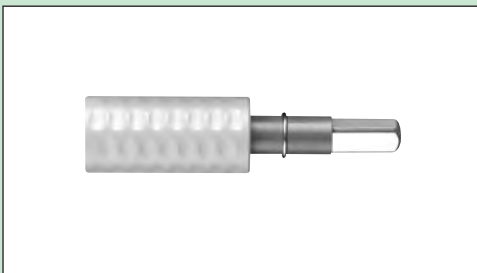

429-81018

Adapter for Bipolar Cable with Flat Plug
 ■ E.g. usable with MGB-cable (Order-No.: 670-91331)
 ■ For Order-No.: 429-81005, 429-81023

BIPOLAR

BIPOLAR COAGULATION INSTRUMENTS

Products

Order-No.

Description

Ø 3 mm



429-81305

Bipolar Micro Coagulation Forceps

- With standard handle
- Working length: 340 mm

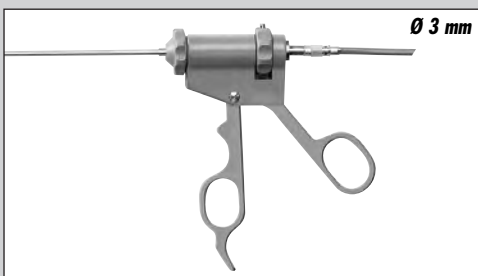

429-81323

Bipolar Micro Coagulation Forceps

- With ring handle
- Working length: 340 mm

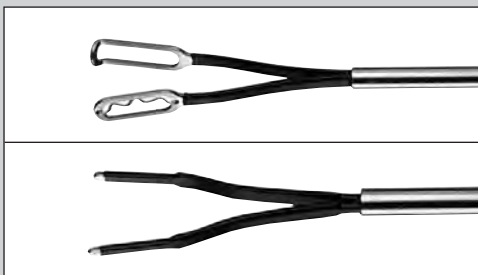

429-81311

Micro Tubal Coagulation Forceps Electrode

- Rippled bar



429-81308

Micro Tweezers Electrode

- Tweezers tip: 1 mm

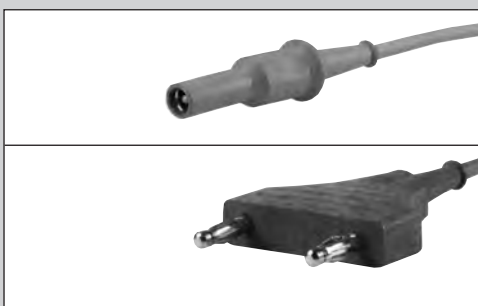

429-81310

Bipolar Connection Cable for Ø 3 mm Instruments

- To Martin-, Berchtold- units
- For Ø 3 mm- handles
- For Order-No.: 429-81305, 429-81323



429-81320

Bipolar Connection Cable for Ø 3 mm Instruments

- To Valleylab-units
- For Ø 3 mm- handles



429-81319

Bipolar Connection Cable

- For MGB-units
- For Ø 3 mm- handles
- For Order-No.: 429-81305, 429-81323

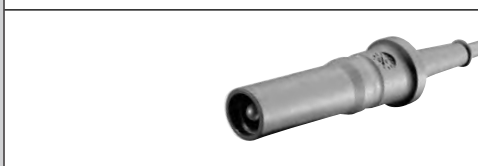

429-81321

Bipolar Connection Cable

- For Erbe-units
- For Ø 3 mm- handles
- For Order-No.: 429-81305, 429-81323

BIPOLAR

BIPOLAR COAGULATION FORCEPS

Products

Order-No.

Description

Ø 5 mm

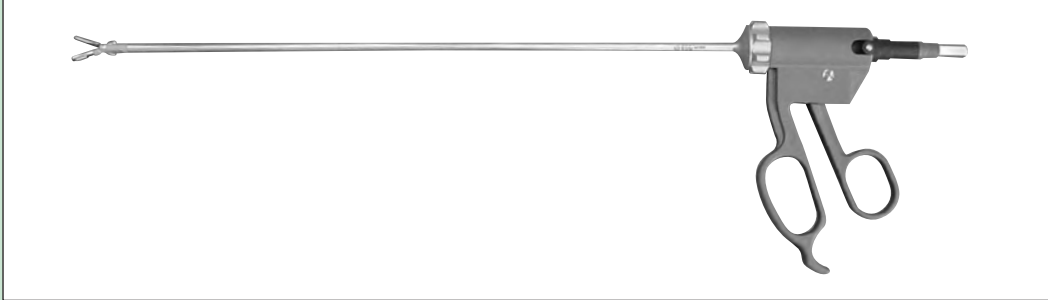

Consist of:

- Handle (Order-No.: 429-81500)
- Shaft (Order-No.: 429-81510)
- Inserts (Order-No.: 429-81540, 429-81520, 429-81530)

Bipolar Instrument

- For active, precise opening and closing by isolated inserts
- 360° rotatable



429-81500

Handle

- Standardized plug
- PEEK polymer

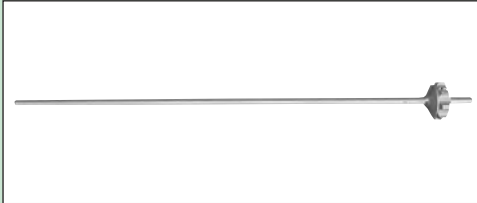

429-81510

Shaft

- Working length: 340 mm
- Ø 5 mm

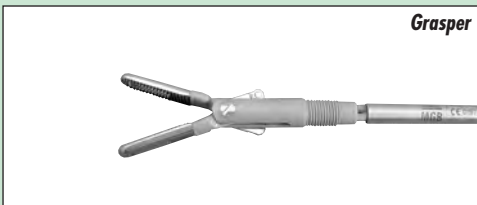

Grasper

429-81520

Insert Bipolar Grasping Forceps

- With join

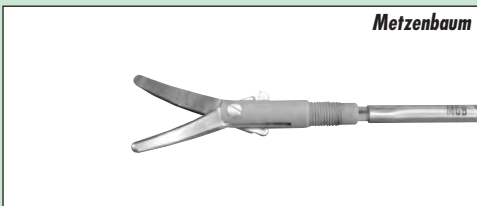

Metzenbaum

429-81530

Insert Bipolar Scissors

- With join

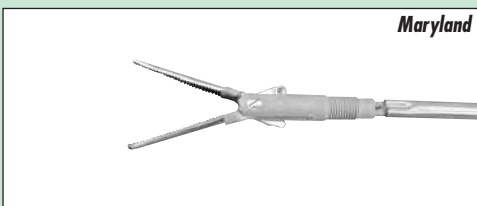

Maryland

429-81540

Insert Bipolar Dissector

- With join

BIPOLAR

BIPOLAR ELECTRODES

Products

Order-No.

Description

Ø 5 mm

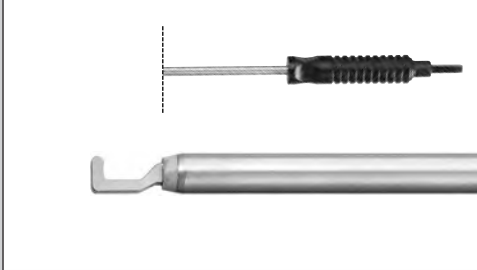

429-81031

Bipolar L-Hook Electrode

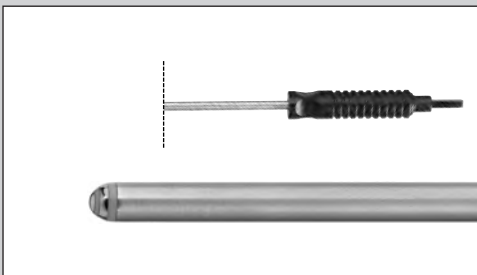

429-81032

Bipolar Cup Electrode

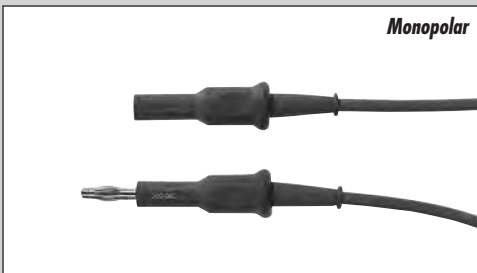

Monopolar

670-91330 (Picture)

670-91333

Connection Cable for Monopolar MIS-Instruments

- To MGB-, Martin-, Berchtold-units
- To Valleylab-units

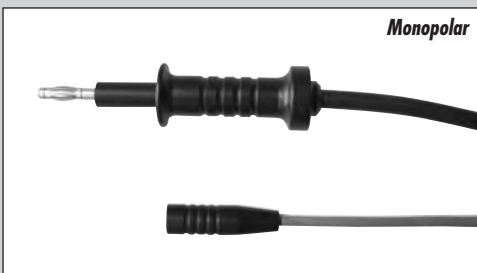

Monopolar

670-91332 (Picture)

670-91337

670-91336

Connection Cable for MGB-Resectoscopes

- To MGB-, Martin-, Berchtold-units
- To Valleylab-units
- To Erbe-, Storz-units

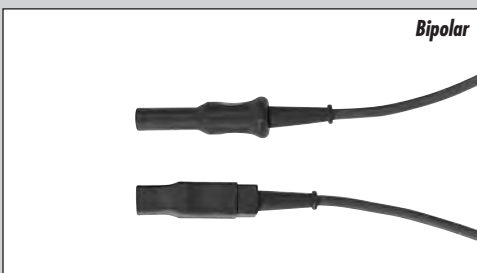

Bipolar

670-91331 (Picture)

670-91334

670-91335

Connection Cable for Bipolar Tweezers

- To Martin-, Berchtold-units
- To MGB-, Valleylab-units
- To Erbe-, Storz-units

ML-G INSUFFLATOR

Order-No.: 670-95600 (220 V)
670-95601 (110 V)



40 Liter/min
Insufflation

For our new insufflators
ME-GX & ML-GX please see
our brochure "Insufflators"

Specification

The latest computer controlled technology for safe and precise insufflation. 4 unique selectable flow standards for exact control of intermittent insufflation (2 l, 8 l, 40 l/min automatic mode). The adjustable preselection of intraabdominal pressure (1-30 mm/Hg) meets every requirement (paediatric, gynaecology, general laparoscopy and bariatric procedure).

High Safety

The ML-G guarantees the highest safety based on electrical control. Additionally, it covers all functions mechanically. Abdominal overpressure will be automatically reduced through integrated gas valve.

Clear Arrangement

Clear arrangement is the essential characteristics of the ML-G. Its display gives a quick overview of the rated and actual values of gas flow- and-pressure. The setting of the flow rate is made by a simple touch of a button. The gas volume is shown by a separate display.

Compatibility

ML-G is compatible to central CO₂ supply or different kind of gas bottles.



Insufflation medium: CO₂ Insufflation Rate

Low: approx. 2 l/min.
Med: approx. 8 l/min.
High: approx. 40 l/min.
Auto: automatic flow



Irrigation Included

The ML-G has a gas pressure Irrigation function, which allows liquids irrigation. In combination with the MGB-Suction-/Irrigation instrument, simple handling and high flow Irrigation is guaranteed.



Voice Feedback

All settings are confirmed acoustically through an adjustable speech module.

GENERAL

Order-No.	
670-95600	ML-G Insufflator 220 V
670-95601	ML-G Insufflator 110 V
Main Connection	
Power supply	100 - 120 V/200 - 240 V
Frequency	50 - 60 Hz
Power consumption	45 VA
Fuse (~100 - 120 V)	2 x T 1.0 A/250 V (IEC 127)
Fuse (~200 - 240 V)	2 x T 2.0 A/120 V (IEC 127)
Classification	
Safety class	1 with potential equalization connection
Protection	IP X 1
Type	BF
Approval	CE
Dimension and Weight	
Dimension (w/h/d)	400 x 200 x 400 mm (without gas bottle)
Weight	17.6 kg
Operating Conditions	
Operating temperature	+10° C ~ +40° C
Operating humidity	30 % ~ 75 %
Extent of Delivery	
ML-G	<ul style="list-style-type: none"> ■ Silicone tube set for Insufflation ■ Disposable Filter for Insufflation ■ Adapter for Insufflation ■ Silicone tube set for Irrigation ■ Power cable
	<ul style="list-style-type: none"> ■ User manual
Interface	
To patient	<ul style="list-style-type: none"> ■ Gas connection: conus
CO ₂ connection	<ul style="list-style-type: none"> ■ Irrigation connection: Luer (male) ■ DIN

SPECIFICATION

Main Unit	
Insufflation medium: CO ₂ , Insufflation rate	<ul style="list-style-type: none"> ■ Low: approx. 2 l/min ■ Med: approx. 8 l/min ■ High: approx. 40 l/min ■ Auto: automatic flow
Intra-abdominal working pressure	<ul style="list-style-type: none"> ■ 0-30 mm Hg infinitely selectable and limitable ■ Maximal pressure of bottle: 80 bar ■ Display of critical low bottle pressure ■ Irrigation P+: 800 mbar

Order-No.	Accessories
670-95300	Silicone tube set for Insufflation
670-95310	CO ₂ gas bottle 1l (empty)
670-95311	Key for CO ₂ gas bottle connection
670-95313	High pressure tube, GI:DIN, bottle: DIN
670-95314	High pressure tube, GI:DIN, bottle: PIN
670-95316	High pressure tube, GI:DIN, bottle: ITALY
670-95341 (100 mm) 670-95342 (120 mm) 670-95340 (150 mm)	Veress needle, Ø 2 mm
675-11200	Gas-filter, 25 pieces
675-11202	Adapter for Insufflation
670-95301	Silicone tube set for Irrigation
670-96330	Irrigation trocar, short (0.5 l)
670-96331	Irrigation trocar, long (1.0 l)
670-96325	Irrigation bottle holder for cart
670-96310	Filter for Irrigation, 10 pieces

LAP-PUMP

PUMP FOR LAPAROSCOPY

Order-No.: 670-96100

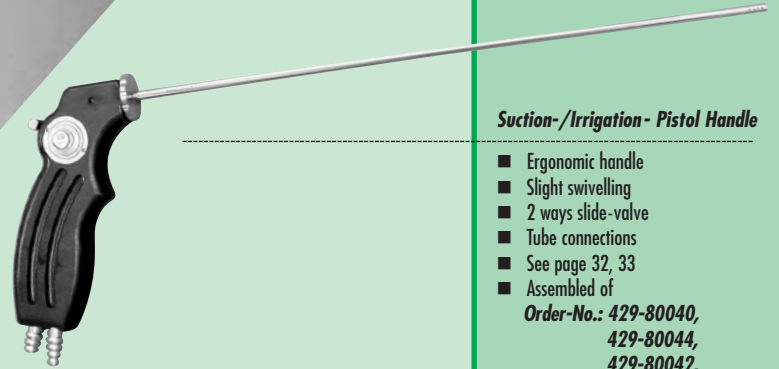

Specification

- Simple and noiseless operation
- Easy to load latex-free tube set
- High safety
- Suction included
- To use with fluid bag

Suction-/Irrigation - Pistol Handle

- Ergonomic handle
- Slight swivelling
- 2 ways slide-valve
- Tube connections
- See page 32, 33
- Assembled of
Order-No.: 429-80040,
429-80044,
429-80042,
429-80043

GENERAL

Order-No.	
670-96100	Laparoscopy - Pump
Main Connection	
Power supply	<ul style="list-style-type: none"> ■ ~ 100 V AC ■ ~ 110 - 115 V AC ■ ~ 220 - 240 V AC
Frequency	50 - 60 Hz
Power consumption	55 VA
Fuse	2 x T 2, 0A/250 V
Classification	
Safety class	1 with potential equalization connection
Protection	IP 41
Type	BF
Approval	CE
Dimension and Weight	
Dimension (w/h/d)	280 x 137 x 408 mm
Weight	5.9 kg
Extent of Delivery	
Laparoscopy - Pump	<ul style="list-style-type: none"> ■ Main power cable ■ User manual

SPECIFICATION

Main Unit	
Max. flow rate Irrigation	1.8 l/min. (± 10 %)
Suction	1.8 l/min. (+ 0.4/-0.1 l/min.)
Max. pump capacity	400 mm Hg (± 50 mm Hg)
Suction	Between -50 kpa and -60 kpa

Order-No.	Accessories
670-96410	Limited use tubing set (irrigation)
670-96420	Disposable tubing set (irrigation)
670-96460	10 x membrane for pressure chamber for limited use tubing set (spare-part)
670-96480	Limited use tubing set (vacuum)
670-96490	Limited use tubing set (suction)

MORCELLATOR

MORCELLATOR »SET POWER«

Order-No.: 429-10100

Set consists of:

- Control Unit
- Motor
- Gear box
- Cable

Attention

Cutting tube is not content of this set!

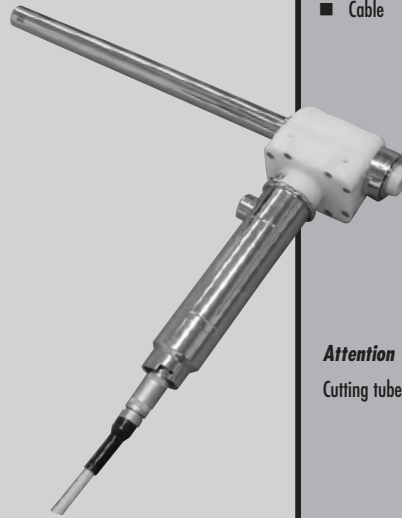

Morcellator »Set Power«

- Uncomplicated and time-saving tissue Morcellation
- Riskless intraabdominal Morcellation of large tissues
- Tissue cylinders can be removed from Myomas, Uteri, Renal and Splenic tissues etc. by motorized rotation of the SET-POWER in a continuous and precise mode
- SET-POWER is operated by mains connection
- Constant torsional moment: no decrease in performance (when treating big and hard Myomas)
- Maintenance-free world power supply (100-240 V)
- Motor, gear and Morcellator tubes are connected by rapid coupling
- Function ON/OFF at the motor handle
- Ergonomically shaped handle guarantees optimal handling
- Useable for cutting tubes toothed edge (10 mm/15 mm/20 mm)
- Operating display of SET-POWER in the controlling unit
- Gear box autoclaveable at 134 °C
- Drive Motor autoclaveable at 134 °C by means of protective caps
- Cable length 3 m

GENERAL

Order-No.	
429-10100	Morcellator »Set Power«
Main Connection »Set Power«	
Power supply	~100 - 240 V AC
Frequency	50 - 60 Hz
Power consumption	110 VA
Classification »Set Power«	
Safety class	1 with potential equalization connection
Type	BF
Approval	CE
Dimension and Weight »Control Unit«	
Dimension (w/h/d)	350 x 90 x 290 mm
Weight	3.6 kg
Extent of Delivery »Set Power«	
Morcellator »Set Power«	<ul style="list-style-type: none"> ■ Control unit ■ Gear box ■ Handbox ■ Cable

SPECIFICATION

Dimension and Weight »Motor/Gear box«	
Dimension (w/h)	175 x 41 mm
Weight	0.94 kg

Order-No.	Accessories
429-10300	Cutting tube Ø 10 mm (5 mm Instr.)
429-10400	Cutting tube Ø 15 mm (10 mm Instr.)
429-10500	Cutting tube Ø 20 mm (10 mm Instr.)
429-90021	Sealing caps for Ø 15 mm/Ø 20 mm cutting tubes
429-90020	Sealing caps for Ø 10 mm cutting tubes

ACCESSORIES FOR MORCELLATOR

Products

Order-No.

Description

Working Length: 245 mm



429-10300
429-10400
429-10500
429-90021
429-90020

Cutting Tubes Toothed Edge

- Ø 10 mm (5 mm Instr.)
- Ø 15 mm (10 mm Instr.)
- Ø 20 mm (10 mm Instr.)
- Sealing caps for Ø 15, Ø 20 mm cutting tubes
- Sealing caps for Ø 10 mm cutting tubes

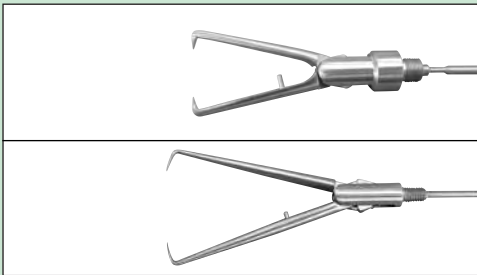

429-75282/44

Insert Tenaculum

- Ø 10 mm for 440 mm shafts

429-75283/44

- Ø 5 mm for 440 mm shafts

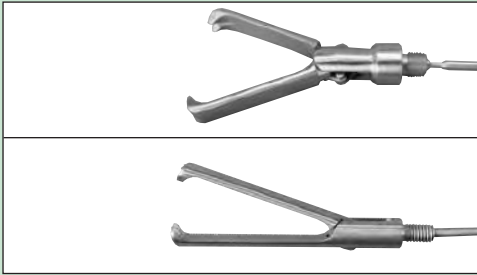

a 429-75281/44
(For 440 mm shafts)

a Insert Claw Forceps Ø 10 mm

- 2 to 3 teeth
- Sharp
- Double action

b 429-75171/44
(For 440 mm shafts)

b Insert Claw Forceps Ø 5 mm

- 2 to 3 teeth
- Sharp
- Double action



429-77030

GRP-Laparoscopic Handle Polymer with Ratchet

- With HF-connection
- Fibre-reinforced

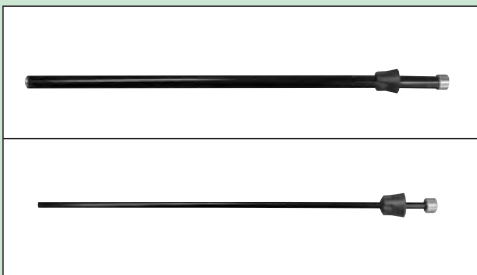

429-75061/44

Insulated Shaft with Shaft knob Ø 10 mm

- Working length: 440 mm

429-75065/44

Insulated Shaft with Shaft knob Ø 5 mm

- Working length: 440 mm

ACCESSORIES FOR MORCELLATOR

Products

Order-No.

Description



429-10600

Myoma Drill

- Ø 10 mm
- Working length: 420 mm

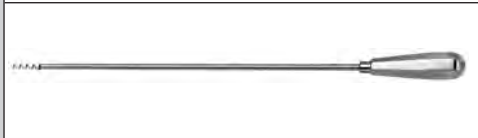

429-10650

Myoma Drill

- Ø 5 mm
- Working length: 420 mm



429-40022

Flap Valve Trocar Sleeve

- Ø 11 mm
- Working length: 101 mm

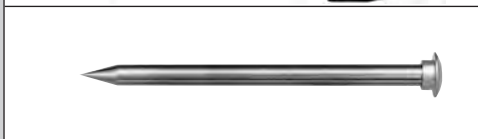

429-40133

Conical Trocar

- Ø 11 mm
- Working length: 193 mm

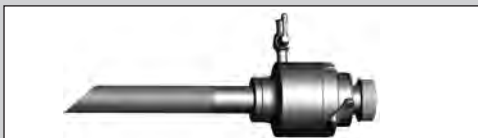

429-40041 (Ø 15 mm)
429-40042 (Ø 20 mm)

Flap Valve Trocar Sleeve

- Working length: 110 mm
- Working length: 120 mm



429-90022 (2 pcs.)
429-90021 (2 pcs.)
429-90020 (2 pcs.)

Sealing Caps

- Ø 10 mm/Ø 10.5 mm/Ø 11.0 mm
- Ø 15 mm
- Ø 20 mm



429-23212

Dilatation Sleeve with Rod

- Ø 11 mm - Ø 15 mm

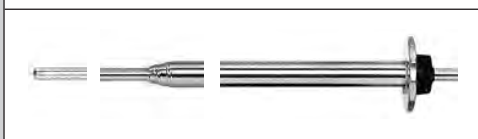

429-23215

- Ø 11 mm - Ø 20 mm



429-10250

Hand Wheel

- For Ø 10 mm/Ø 15 mm and Ø 20 mm cutting tubes

General Surgery – Laparoscopy

Urology – Cystoscopy – Ureterorenoscopy – Nephroscopy – Resectoscopy

Gynecology – Hysteroscopy – Resectoscopy

Arthroscopy – Shaver System

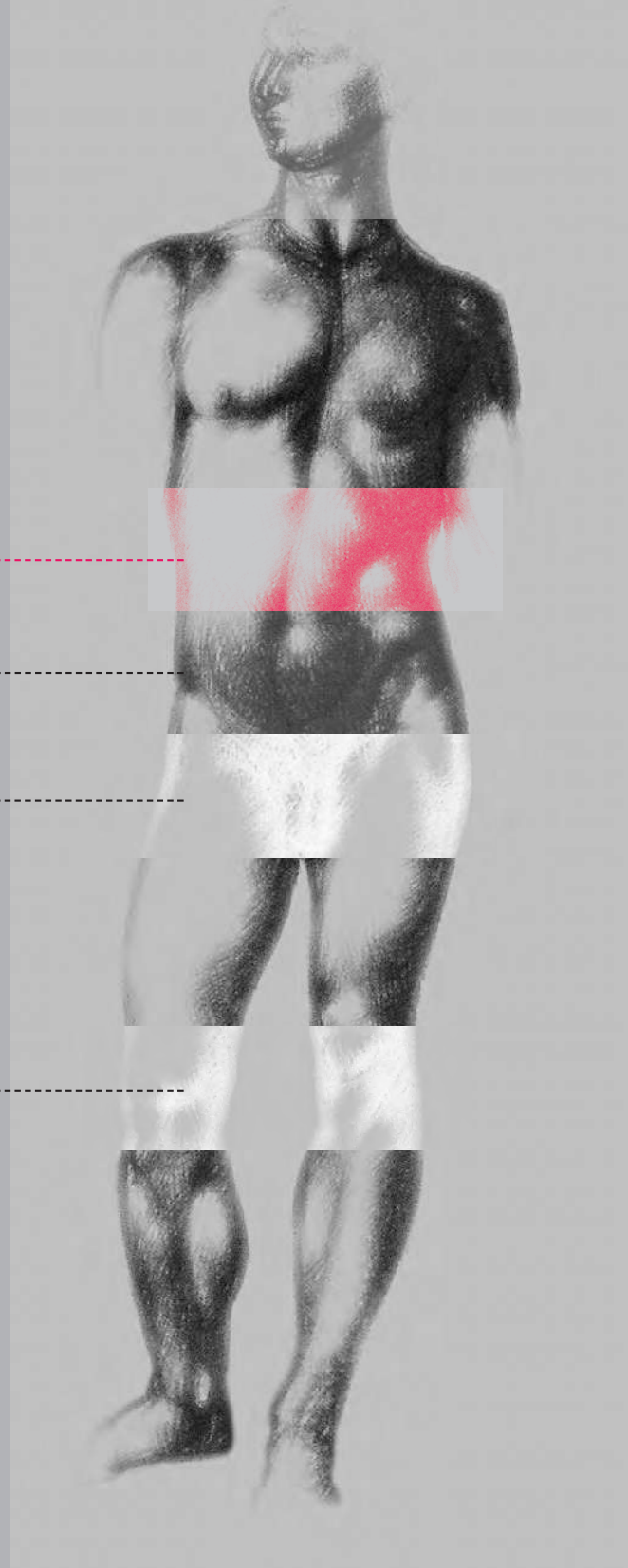

По вопросам продаж и поддержки обращайтесь:

Алматы (7273)495-231
Ангарск (3955)60-70-56
Архангельск (8182)63-90-72
Астрахань (8512)99-46-04
Барнаул (3852)73-04-60
Белгород (4722)40-23-64
Благовещенск (4162)22-76-07
Брянск (4832)59-03-52
Владивосток (423)249-28-31
Владикавказ (8672)28-90-48
Владимир (4922)49-43-18
Волгоград (844)278-03-48
Вологда (8172)26-41-59
Воронеж (473)204-51-73
Екатеринбург (343)384-55-89

Иваново (4932)77-34-06
Ижевск (3412)26-03-58
Иркутск (395)279-98-46
Казань (843)206-01-48
Калининград (4012)72-03-81
Калуга (4842)92-23-67
Кемерово (3842)65-04-62
Киров (8332)68-02-04
Коломна (4966)23-41-49
Кострома (4942)77-07-48
Краснодар (861)203-40-90
Красноярск (391)204-63-61
Курган (3522)50-90-47
Курск (4712)77-13-04
Липецк (4742)52-20-81

Магнитогорск (3519)55-03-13
Москва (495)268-04-70
Мурманск (8152)59-64-93
Набережные Челны (8552)20-53-41
Нижегород (831)429-08-12
Новокузнецк (3843)20-46-81
Новосибирск (383)227-86-73
Ноябрьск (3496)41-32-12
Омск (3812)21-46-40
Орел (4862)44-53-42
Оренбург (3532)37-68-04
Пенза (8412)22-31-16
Пермь (342)205-81-47
Петрозаводск (8142)55-98-37
Псков (8112)59-10-37

Ростов-на-Дону (863)308-18-15
Рязань (4912)46-61-64
Самара (846)206-03-16
Санкт-Петербург (812)309-46-40
Саранск (8342)22-96-24
Саратов (845)249-38-78
Севастополь (8692)22-31-93
Симферополь (3652)67-13-56
Смоленск (4812)29-41-54
Сочи (862)225-72-31
Ставрополь (8652)20-65-13
Сургут (3462)77-98-35
Сыктывкар (8212)25-95-17
Тамбов (4752)50-40-97
Тверь (4822)63-31-35

Тольятти (8482)63-91-07
Томск (3822)98-41-53
Тула (4872)33-79-87
Тюмень (3452)66-21-18
Улан-Удэ (3012)59-97-51
Ульяновск (8422)24-23-59
Уфа (347)229-48-12
Хабаровск (4212)92-98-04
Чебоксары (8352)28-53-07
Челябинск (351)202-03-61
Череповец (8202)49-02-64
Чита (3022)38-34-83
Якутск (4112)23-90-97
Ярославль (4852)69-52-93

Россия +7(495)268-04-70

Казахстан +7(7172)727-132

Киргизия +996(312)96-26-47

mvi@nt-rt.ru || <https://mgb.nt-rt.ru>